

In-Car Receiver
XAV-AX6000/XAV-AX6050



Use this manual if you encounter any problems, or have any questions.

Note: The unit sold in some countries/regions may differ from the picture above.

Getting Started

Guide to Parts and Controls

[Main Unit and Remote Commander](#)

[Screen Displays](#)

[Performing Initial Settings](#)

Using Apple CarPlay / Android Auto

[Using Apple CarPlay Wirelessly](#)

[Using Android Auto™ Wirelessly](#)

[Using Android Auto with a USB Cable](#)

Preparing a BLUETOOTH Device

[Pairing and Connecting with a Bluetooth® Device](#)

[Connecting with a Paired BLUETOOTH Device](#)

[Using a Rear View Camera](#)

Smartphone Connection

[Apple CarPlay](#)

[Android Auto](#)

Radio

Listening to the Radio

[Listening to the Radio](#)

[Tuning](#)

[Using Radio Option Functions](#)

Listening to the SiriusXM Radio (XAV-AX6000(UC))

[Listening to the SiriusXM Radio](#)

[Tuning Channels for SiriusXM](#)

[Tuning the Channel by Inputting its Channel Number](#)

[Tuning the Channel by TuneScan™](#)

[Tuning the Channel from the Channel List or Category List](#)

[Setting a Parental Control](#)

[Using SXM Option Functions](#)

Listening to the DAB/DAB+ Radio (XAV-AX6050(EUR))

[Listening to the DAB/DAB+ Radio](#)

[Using DAB Option Functions](#)

Playback

Playing a USB Device

[Playing a USB Device](#)

[Repeat Play and Shuffle Play](#)

[Searching for a File from the List Screen](#)

[Other Settings during Playback](#)

Playing an HDMI Device

[Playing an HDMI™ Device](#)

[Other Settings during Playback](#)

Playing a BLUETOOTH Device

[Playing a BLUETOOTH Device](#)

[Repeat Play and Shuffle Play](#)

Handsfree Calling

[Preparing a Mobile Phone](#)

[Receiving a Call](#)

[Making a Call](#)

[Available Operations during a Call](#)

iDataLink Maestro (XAV-AX6000(UC))

[Getting iDataLink Maestro Ready](#)

[Using iDataLink Maestro](#)

Settings

[Basic Setting Operation](#)

[Device Connection](#)

[Sound](#)

[Customize](#)

[Application](#)

[System](#)

Additional Information

[Canceling the Demonstration Mode](#)

[Sorting Apps on the Apps Area \(Favorite\)](#)

[Updating the Software](#)

[Precautions](#)

[Supported Formats for USB Playback](#)

[About iPhone](#)

[Notice on License](#)

[Maintenance](#)

[Specifications](#)

[Copyrights](#)

Troubleshooting

[Troubleshooting](#)

General

- └ [There is no beep sound.](#)

- └ [The fuse has blown. / The unit makes noise when the position of the ignition is switched.](#)

- └ [The display disappears from the monitor. / The display does not appear on the monitor.](#)

- └ [Menu items cannot be selected.](#)

- └ [The unit cannot be operated.](#)

Touch Screen

- └ [The touch screen does not react to your touch correctly.](#)

- └ [Multi-touch is not recognized.](#)

Device Connection

- └ [A suffix such as "-2", "-3", ... appears after the name of the device on \[Device Connection\].](#)

Radio

- └ [The radio reception is poor. / Static noise occurs.](#)

- └ [The stations cannot be received. \(XAV-AX6000\(E\)/XAV-AX6000\(E17\)/XAV-AX6000\(IN\)/XAV-AX6050\(EUR\)\).](#)

DAB/DAB+ Radio (XAV-AX6050(EUR))

- └ [Stations cannot be received.](#)

- └ [No FM RDS traffic announcements.](#)

Picture

- └ [There is no picture or picture noise occurs.](#)

Sound

- └ [There is no sound, sound skips, or sound cracks.](#)

- └ [Sound is noisy.](#)

USB playback

- └ [Items cannot be played.](#)

- └ [The USB device takes longer to play.](#)

[The smartphone connected to the USB port cannot be played.](#)

HDMI playback

[The connected HDMI device cannot be played.](#)

BLUETOOTH

[The other BLUETOOTH device cannot detect this unit.](#)

[Connection is not possible.](#)

[The name of the detected device does not appear.](#)

[There is no ringtone.](#)

[The talker's voice volume is low.](#)

[The other party says that the volume is too low or high.](#)

[Echo or noise occurs during call conversations.](#)

[The phone sound quality is poor.](#)

[The volume of the connected BLUETOOTH device or apps is low or high.](#)

[The sound skips during audio streaming or the BLUETOOTH connection fails.](#)

[The connected BLUETOOTH device cannot be controlled during audio streaming.](#)

[Some functions do not work.](#)

[A call is answered unintentionally.](#)

[Pairing failed due to time out.](#)

[Cannot pair.](#)

[The BLUETOOTH function cannot be operated.](#)

[No sound is output from the car speakers during a handsfree call.](#)

SiriusXM Connect Vehicle Tuner (XAV-AX6000(UC))

[A mature channel is not blocked although parental control setting has been made.](#)

Apple CarPlay

[The Apple CarPlay icon does not appear on the HOME screen.](#)

[The position accuracy is not good when using maps with Apple CarPlay.](#)

Android Auto

[The Android Auto icon does not appear on the HOME screen.](#)

[The position accuracy is not good when using maps with Android Auto.](#)

iDataLink Maestro (XAV-AX6000(UC))

[iDataLink Maestro](#)

Messages

[General](#)

[SiriusXM Connect Vehicle Tuner \(XAV-AX6000\(UC\)\)](#)

[DAB radio \(XAV-AX6050\(EUR\)\)](#)

Support Websites

[Customer Support Websites](#)

[About the “Support by Sony” App](#)

In-Car Receiver
XAV-AX6000/XAV-AX6050

Main Unit and Remote Commander

Main unit

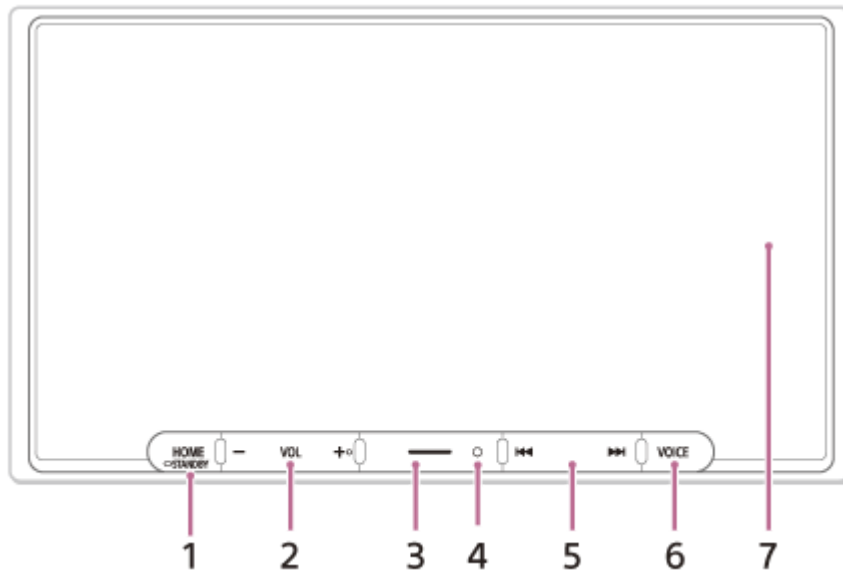

The VOL (volume) + button has a tactile dot.

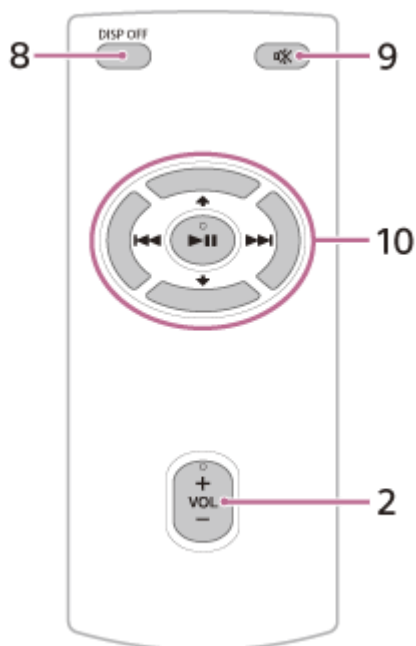

RM-X400 remote commander (XAV-AX6000(E)/XAV-AX6000(E17)/XAV-AX6000(IN))

The remote commander can be used to operate the audio controls. For menu operations, use the touch screen.



The VOL (volume) +/▶II (play/pause) buttons have a tactile dot.

Note

- The  /  (up/down) buttons in the illustration above are not supported.

Remove the insulation film before use.

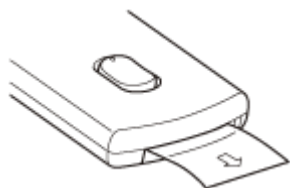

Hint

- For XAV-AX6000(UC), the RM-X400 remote commander is available online at <https://encompass.com>.

1. HOME

Displays the HOME screen.

STANDBY

Press and hold to turn off the unit.

Press and hold for more than 10 seconds to reset the unit.

2. VOL (volume) +/-

3. Custom

Registers functions (Mute, Disp. Off (display off), Source Change).

To register, select [Settings] → [Customize] → [Custom Button].

4. Receptor for the remote commander

5. / (previous/next)

Functions differently depending on the selected source:

[Radio]: select a preset station.

[SiriusXM]: select a preset channel. (XAV-AX6000(UC))

[DAB+]: select a preset station. (XAV-AX6050(EUR))

[USB]: move to the previous/next content.

[Bluetooth Audio]: move to the previous/next content.

[Apple CarPlay]/[Android Auto]: move to the previous/next content.

Press and hold to:

[Radio]: tune into a station automatically (SEEK+/SEEK-).

[DAB+]: select a station from the Station List. (XAV-AX6050(EUR))

[USB]: fast-reverse/fast-forward.

[Bluetooth Audio]: fast-reverse/fast-forward.

6. VOICE

Activates the voice command function for Apple CarPlay and Android Auto.

7. Display/touch screen

8. DISP OFF (display off)

Turns off the display.

To turn back on, press again.

9. (mute)

Mutes the sound. To cancel, press again.

10. (play/pause)

/ (previous/next)

Functions differently depending on the selected source:

[Radio]: select a preset station.

[SiriusXM]: select a preset channel. (XAV-AX6000(UC))

[DAB+]: select a preset station. (XAV-AX6050(EUR))

[USB]: move to the previous/next content.

[Bluetooth Audio]: move to the previous/next content.

[Apple CarPlay]/[Android Auto]: move to the previous/next content.

Press and hold to:

[Radio]: tune into a station automatically (SEEK+/SEEK-).

[DAB+]: select a station from the Station List. (XAV-AX6050(EUR))

[USB]: fast-reverse/fast-forward.

[Bluetooth Audio]: fast-reverse/fast-forward. Functions differ depending on the BLUETOOTH device.

Related Topic

- [Screen Displays](#)

5-035-402-11(6) Copyright 2022 Sony Corporation

In-Car Receiver
XAV-AX6000/XAV-AX6050

Screen Displays

Playback screen:

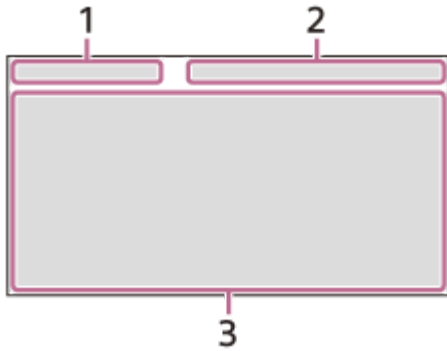

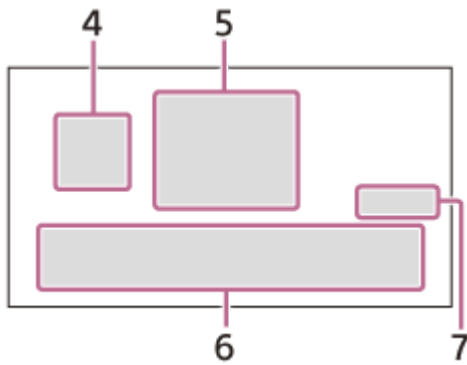

HOME1 screen:



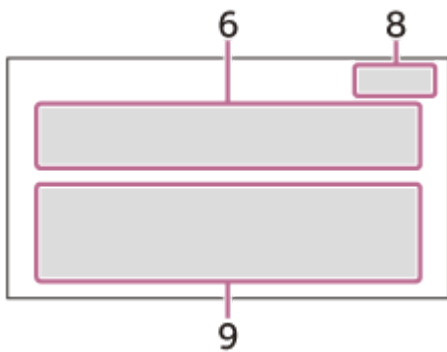



HOME2 screen:



1. Status indication (left side)

Icon in the display	Detail
 (back)	Returns to the previous display.
 (list)	Opens the list. The available lists differ depending on the source.

2. Status indication (right side)

Icon in the display	Detail
Clock	Displays the time which was set on the Date/Time setting.
 (mute)	Lights up when the sound is muted.
 (option)	Opens the source option menu. The available items differ depending on the source.
 (device)	Displays the device's name to connect to the unit.
 (antenna)	Indicates the signal strength status of the connected mobile phone.
 (battery)	Indicates the remaining battery status of the connected mobile phone.

3. Application specific area

Displays playback controls/indications or shows the unit's status. Displayed items differ depending on the source.

4. (Apple CarPlay)/ (Android Auto)

Displays when connecting Apple CarPlay/Android Auto.

5. Clock

Displays the date and time which were set on the Date/Time setting.

6. Apps area (Favorite)

Up to 5 Apps can be set. Apps can be changed. You can set your Favorite Apps.

7. All Apps

Opens the HOME2 screen.

8. Close







Returns to the HOME1 screen.











9. Apps area

Displays all Apps except for Favorite Apps.

Apps icon list

XAV-AX6000(UC):

Icon in the display	Name
	Android Auto
	Apple CarPlay
	Radio
	SiriusXM
	Bluetooth
	RearCam
	Settings











Icon in the display	Name
	USB
	HDMI
	Devices
	Phone
	Gauges *1*2
	Park Assist *1*2
	Vehicle Info *1*2
	Climate *1*2
	Satellite Radio*1*2*3
	Bluetooth Audio*1*2*3
	Media Player*1*2*3

*1 When connecting the iDataLink Maestro module (not supplied), the icon is displayed.

*2 Available functions differ according to your car type.

*3 The display names differ according to your car type.











XAV-AX6000(E)/XAV-AX6000(E17)/XAV-AX6000(IN):

Icon in the display	Name
	Android Auto*
	Apple CarPlay*
	Radio
	Bluetooth
	USB
	Phone
	Settings
	HDMI
	RearCam
	Devices

* It may not be available in your country or region.

XAV-AX6050(EUR):

Icon in the display	Name
	Android Auto

Icon in the display	Name
	Apple CarPlay
	Radio
	DAB+
	Bluetooth
	Phone
	Settings
	USB
	HDMI
	RearCam
	Devices

Related Topic



- [System](#)
- [Sorting Apps on the Apps Area \(Favorite\)](#)

In-Car Receiver
XAV-AX6000/XAV-AX6050

Performing Initial Settings

You need to perform initial settings before operating the unit for the first time, after replacing the car battery, or changing connections.

If the initial settings screen does not appear when you turn on the unit, perform the factory reset to initialize the unit.

- 1 Touch [Language], then set the display language.**
To return to the previous display, touch  (back).
- 2 Touch [Demo Mode] repeatedly to select [Off] to disable the demonstration mode.**
- 3 Touch [Set Date/Time], then set the date and time.**
To return to the previous display, touch  (back).
XAV-AX6000(UC): skip to step 5.
- 4 Touch [Radio Tuning Steps], then set the radio frequency depending on the receiving area. (XAV-AX6000(E)/XAV-AX6000(E17)/XAV-AX6000(IN)/XAV-AX6050(EUR))**
- 5 Touch [OK].**
The startup caution appears.
- 6 Read through the startup caution, then if you accept all conditions, touch [Close].**
The setting is complete.

This setting can be further configured in the setting menu.

Related Topic

- [Device Connection](#)
- [Sound](#)
- [Customize](#)
- [Application](#)
- [System](#)

In-Car Receiver
XAV-AX6000/XAV-AX6050

Using Apple CarPlay Wirelessly

When using Apple CarPlay for the first time, device registration (called “pairing”) is required. Pairing enables this unit and your iPhone to recognize each other.



Note

- Make sure the GPS antenna (aerial) (supplied) is connected.

1 Place your iPhone within 1 m (3 ft) of this unit.

2 Press HOME, then touch [Settings].

If [Settings] is not set in the Favorite area, touch [All Apps] to display the HOME2 screen, then select [Settings].

Hint

- You can touch [Devices] to open the [Device Connection] screen alternatively.

3 Touch [Device Connection].

4 Touch [+Add New Device].

5 Operate your iPhone according to its message on the [Add New Device] screen.

When setting the BLUETOOTH setting, Wi-Fi setting, and Apple CarPlay of your iPhone to [ON], select “XAV-AX6000” on the setting screen of your iPhone and then proceed to the pairing steps.

6 [Pairing Request] appears on the unit.

Confirm the [Passkey:].

The same 6-digit passkey appears on your iPhone and the unit.

7 Touch [Pair], then touch [Apple CarPlay].

Note

- When pairing the unit with your iPhone via BLUETOOTH, the unit will not prompt you to enter a 6-digit passkey. If you are prompted to enter a passkey on your iPhone during pairing, it may be a passkey fraud by a malicious third party who intercepts the communication between your iPhone and the unit. We recommend that you pay close attention around the vicinity of your car and make sure that there are no untrustworthy third parties around you before starting pairing again.

- The unit can only be connected with one iPhone device at a time.
- To disconnect the BLUETOOTH connection, turn the connection off from either the unit or your iPhone.
- While using Apple CarPlay, BLUETOOTH connection is not possible. BLUETOOTH pairing is possible.
- When using Apple CarPlay, remove the HDMI cable from your iPhone. The HDMI connection is not possible while Apple CarPlay is running.
- Apple CarPlay may not be available in your country or region.

Related Topic

- [Apple CarPlay](#)
- [Device Connection](#)

5-035-402-11(6) Copyright 2022 Sony Corporation

In-Car Receiver
XAV-AX6000/XAV-AX6050

Using Android Auto™ Wirelessly

When using Android Auto for the first time, device registration (called “pairing”) is required. Pairing enables this unit and an Android Auto compatible Android™ phone to recognize each other.



1 Place your Android phone within 1 m (3 ft) of this unit.

2 Press HOME, then touch [Settings].

If [Settings] is not set in the Favorite area, touch [All Apps] to display the HOME2 screen, then select [Settings].

Hint

- You can touch [Devices] to open the [Device Connection] screen alternatively.

3 Touch [Device Connection].

4 Touch [+Add New Device].

5 Operate your Android phone according to its message on the [Add New Device] screen.

When setting the BLUETOOTH setting, Wi-Fi setting, and Android Auto of your Android phone to [ON], select “XAV-AX6000” on the setting screen of your Android phone and then proceed to the pairing steps.

6 [Pairing Request] appears on the unit.

Confirm the [Passkey:].

The same 6-digit passkey appears on your Android phone and the unit.

7 Touch [Pair], then touch [Start].

Note

- When pairing the unit with your Android phone via BLUETOOTH, the unit will not prompt you to enter a 6-digit passkey. If you are prompted to enter a passkey on your Android phone during pairing, it may be a passkey fraud by a malicious third party who intercepts the communication between your Android phone and the unit. We recommend that you pay close attention around the vicinity of your car and make sure that there are no untrustworthy third parties around you before starting a pairing again.
- The unit can only be connected with one Android phone at a time.
- To disconnect the BLUETOOTH connection, turn the connection off from either the unit or your Android phone.
- While using Android Auto, BLUETOOTH connection is not possible. BLUETOOTH pairing is possible.

- When using Android Auto, remove the HDMI cable from your Android phone. The HDMI connection is not possible while Android Auto is running.
- Android Auto may not be available in your country or region.

Related Topic

- [Android Auto](#)
- [Device Connection](#)

5-035-402-11(6) Copyright 2022 Sony Corporation

In-Car Receiver
XAV-AX6000/XAV-AX6050

Using Android Auto with a USB Cable

When using Android Auto with a USB cable, connect an Android Auto compatible Android phone to the unit with the USB cable.

1 Connect your Android phone to the USB port.

Note

- While using Android Auto, BLUETOOTH connection is not possible. BLUETOOTH pairing is possible.
- Android Auto may not be available in your country or region.

Related Topic

- [Android Auto](#)

In-Car Receiver
XAV-AX6000/XAV-AX6050

Pairing and Connecting with a Bluetooth® Device

You can enjoy music or perform handsfree calling depending on the BLUETOOTH compatible device such as smartphones, mobile phones, and audio devices (hereafter “BLUETOOTH device” if not otherwise specified). For details on connecting, refer to the operating instructions supplied with the BLUETOOTH device. Before connecting the BLUETOOTH device, turn down the volume of this unit; otherwise, a loud sound may result.

When connecting a BLUETOOTH device for the first time, mutual registration (called “pairing”) is required. Pairing enables this unit and other BLUETOOTH devices to recognize each other.



1 Place the BLUETOOTH device within 1 m (3 ft) of this unit.

2 Press HOME, then touch [Settings].

If [Settings] is not set in the Favorite area, touch [All Apps] to display the HOME2 screen, then select [Settings].

Hint

- You can touch [Devices] to open [Device Connection] alternatively.

3 Touch [Device Connection].

4 Touch [+Add New Device].

5 Operate the BLUETOOTH device according to its message on the [Add New Device] screen.

When setting the BLUETOOTH setting of the BLUETOOTH device to [ON], select “XAV-AX6000” on the setting screen of your BLUETOOTH device and then proceed to the pairing steps.

6 [Pairing Request] appears on the unit.

Confirm the [Passkey:].

The same 6-digit passkey appears on your BLUETOOTH device and the unit.

7 Touch [Pair].

Note

- When pairing the unit with your BLUETOOTH device via BLUETOOTH, the unit will not prompt you to enter a 6-digit passkey. If you are prompted to enter a passkey on your BLUETOOTH device during pairing, it may be a passkey fraud by a malicious third party who intercepts the communication between your BLUETOOTH device and the unit.

We recommend that you pay close attention around the vicinity of your car and make sure that there are no untrustworthy third parties around you before starting a pairing again.

- The unit can only be connected with one BLUETOOTH device at a time.
- To disconnect the BLUETOOTH connection, turn the connection off from either the unit or the BLUETOOTH device.
- BLUETOOTH connection is not possible while Apple CarPlay or Android Auto is running. BLUETOOTH pairing is possible on the [Device Connection] or [Add New Device] screen.
- When making a BLUETOOTH connection with your iPhone or Android phone, remove the HDMI cable from your iPhone or Android phone. The HDMI connection is not possible while using BLUETOOTH connection.

Related Topic

- [Device Connection](#)

5-035-402-11(6) Copyright 2022 Sony Corporation

In-Car Receiver
XAV-AX6000/XAV-AX6050

Connecting with a Paired BLUETOOTH Device

To use a paired BLUETOOTH device, connection with this unit is required. Some paired BLUETOOTH devices will connect automatically.



Activate the BLUETOOTH function on the BLUETOOTH device.

1 Press HOME, then touch [Settings].

If [Settings] is not set in the Favorite area, touch [All Apps] to display the HOME2 screen, then select [Settings].

2 Touch [Device Connection].

The list of paired BLUETOOTH devices appears.
Select the BLUETOOTH device.

To connect from the BLUETOOTH device

When setting the BLUETOOTH setting of the BLUETOOTH device to [ON], select “XAV-AX6000” on the setting screen of your BLUETOOTH device. Connection is made automatically.

To connect the last-connected BLUETOOTH device from this unit

When the ignition is turned to on with the BLUETOOTH signal activated, this unit searches for the last-connected BLUETOOTH device, and connection is made automatically.

To capture your voice during handsfree calling

You need to install the microphone (supplied).

To install the microphone (supplied)

Connect the microphone (supplied) to the MIC IN connector.
For details, refer to “Operating Instructions” (supplied).



Set the connected microphone in your car.

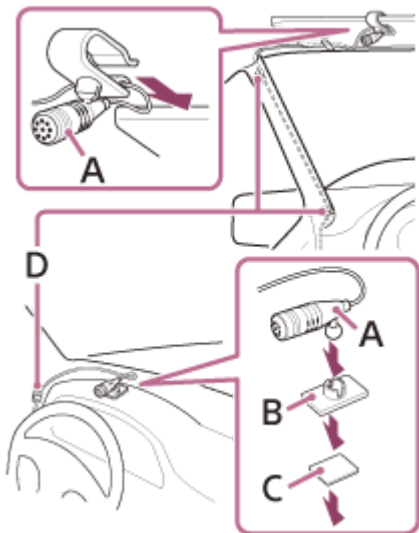

- A. Microphone (supplied)
- B. Flat-mount base (supplied)
- C. Double-sided tape (supplied)
- D. Clip (not supplied)

5-035-402-11(6) Copyright 2022 Sony Corporation

In-Car Receiver
XAV-AX6000/XAV-AX6050

Using a Rear View Camera

Connect the optional cameras to display the picture from the cameras.

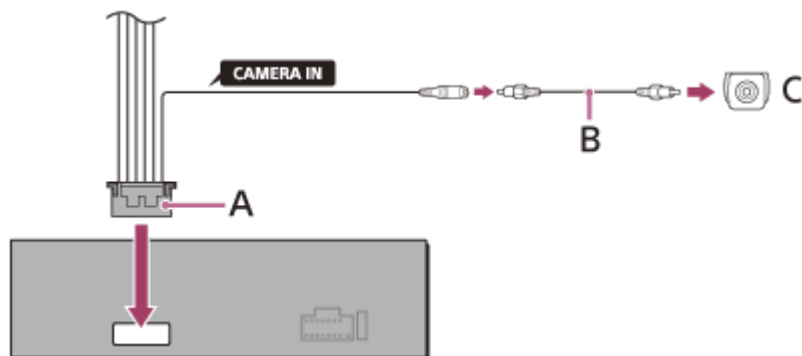

- A. Connection cables (Audio/Camera) (supplied)
- B. RCA pin cord (not supplied)
- C. Rear view camera (not supplied)

To display the picture from the rear view camera

Connect the optional rear view camera to the REAR CAMERA IN cable and connect the REVERSE IN lead to the 12 V power terminal of the car's rear lamp lead to display the picture from the rear view camera when the rear lights of your vehicle are illuminated (or the shift lever is set to the R (reverse) position).

Press HOME, then touch [RearCam].

If [RearCam] is not set in the Favorite area, touch [All Apps] to display the HOME2 screen, then select [RearCam].

In-Car Receiver
XAV-AX6000/XAV-AX6050

Apple CarPlay

Apple CarPlay lets you use your iPhone in the car in a way that allows you to stay focused on the road.

Notes on using Apple CarPlay

- Check the Apple CarPlay website for supported iOS versions. Update to the latest iOS version before use.
- For details about Apple CarPlay, refer to the manual supplied with your iPhone, or visit the Apple CarPlay website.

1 Connect your iPhone to the unit.

When your iPhone and the unit have already been paired, your iPhone and the unit are connected automatically.

2 Press HOME, then touch [Apple CarPlay].

The Apple CarPlay interface will be displayed full-screen on the display of the unit. Touch and control the applications.

Use of the Apple CarPlay logo means that a vehicle user interface meets Apple performance standards. Apple is not responsible for the operation of this vehicle or its compliance with safety and regulatory standards. Please note that the use of this product with iPhone may affect wireless performance.

Related Topic

- [Using Apple CarPlay Wirelessly](#)

In-Car Receiver
XAV-AX6000/XAV-AX6050

Android Auto

Android Auto extends the Android platform into the car in a way that is purpose-built for driving.

Notes on using Android Auto

- Check the Android Auto website for supported OS versions. Update to the latest OS version before use.
- Your Android phone needs to support Android Auto.
- Download the Android Auto app on Google Play.
- For details about Android Auto, refer to the manual supplied with your Android phone, or visit the Android Auto website.
- Android Auto may not be available in your country or region.

1 Connect your Android phone to the unit.

2 Press **HOME**, then touch **[Android Auto]**.

The Android Auto interface will be displayed full-screen on the display of the unit. Touch and control the applications.

Related Topic

- [Using Android Auto™ Wirelessly](#)
- [Using Android Auto with a USB Cable](#)

In-Car Receiver
XAV-AX6000/XAV-AX6050

Listening to the Radio

Press HOME, then touch [Radio].

If [Radio] is not set in the Favorite area, touch [All Apps] to display the HOME2 screen, then select [Radio].

Reception controls/indications

Auto Tune:

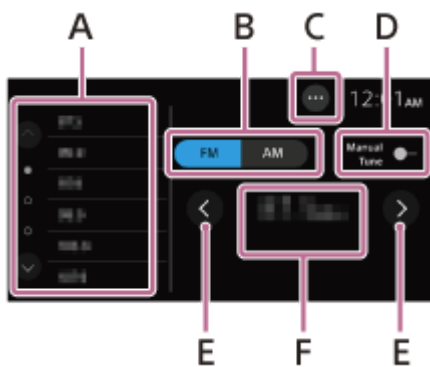

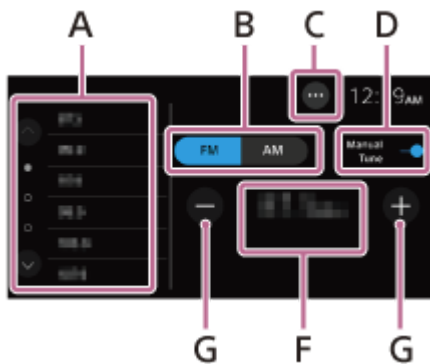

Manual Tune:



A. Preset area

Select a preset station.

Touch and hold to store the current frequency in that preset.

Touch  /  (up/down) to show the other preset stations.

B. Current band

Change the band (FM or AM).

C. ●●● (radio option)

Open the radio option menu.

D. Manual Tune

Switch the tuning between manually and automatically.

E. < / > (left/right)

Tune in automatically.

F. Current frequency, program service name*, RDS (Radio Data System) indication*

* Only available during RDS reception.

G. -/+

Tune in manually.

Touch and hold to continuously skip frequencies.

5-035-402-11(6) Copyright 2022 Sony Corporation

In-Car Receiver
XAV-AX6000/XAV-AX6050

Tuning

1 Select the desired band (FM or AM).

2 Perform tuning.

To tune automatically

Touch **</>** (left/right).

Scanning stops when the unit receives a station.

To tune manually

Touch [Manual Tune] to switch the tuning manually.

Touch **-/+**.

Touch and hold **-/+** to continuously skip frequencies.

To store manually

While receiving the station that you want to store, touch and hold the preset area.

To receive stored stations

Select the band, then touch the desired preset station.

Related Topic

- [Listening to the Radio](#)

In-Car Receiver
XAV-AX6000/XAV-AX6050

Using Radio Option Functions

The following functions are available by touching ●●● (option) on the top-right of the screen.

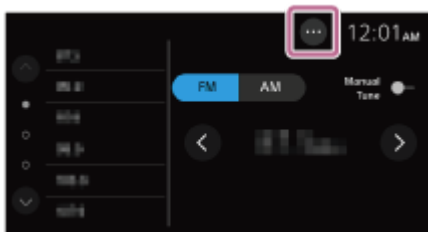

[BTM (Best Tuning Memory)]

Stores stations in order of frequency on the preset numbers. 18 stations for FM and 12 stations for AM can be stored as preset stations.

[Alternate Frequency] (XAV-AX6000(E)/XAV-AX6000(E17)/XAV-AX6000(IN)/XAV-AX6050(EUR))

Selects [On] to continuously retune the station to the strongest signal in a network.
(Only available during FM reception.)

[Traffic Announce] (XAV-AX6050(EUR))

Selects [On] to receive current traffic information or traffic programs (TP) if available.
(Only available during FM reception.)

[Regional Station Link] (XAV-AX6000(E)/XAV-AX6000(E17)/XAV-AX6000(IN)/XAV-AX6050(EUR))

Selects [On] to stay with the station you are receiving while the Alternate Frequency function is set to on. If you leave this regional program's reception area, select [Off]. This function does not work in the UK and some other areas.
(Only available during FM reception.)

[PTY]

Selects a program type from [Music] or [Talk] to search for a station broadcasting the selected program type.
(Only available during FM reception.)

To receive emergency announcements (XAV-AX6000(E)/XAV-AX6000(E17)/XAV-AX6000(IN)/XAV-AX6050(EUR))

With the Alternate Frequency function on, emergency announcements will automatically interrupt the currently selected source.

Related Topic

- [Listening to the Radio](#)

In-Car Receiver
XAV-AX6000/XAV-AX6050

Listening to the SiriusXM Radio

Press HOME, then touch [SiriusXM].

If [SiriusXM] is not set in the Favorite area, touch [All Apps] to display the HOME2 screen, then select [SiriusXM].

To activate your SiriusXM Subscription

Only SiriusXM brings you more of what you love to listen to, all in one place. Get over 140 channels, including commercial-free music plus the best sports, news, talk, comedy and entertainment. Welcome to the world of satellite radio. A SiriusXM Connect Vehicle Tuner and Subscription are required. For more information, visit www.siriusxm.com

After installing your SiriusXM Connect Vehicle Tuner and antenna (aerial), press HOME, then touch [SiriusXM]. You should be able to hear the SiriusXM preview channel on Channel 1. After verifying that you can hear the preview channel, select Channel 0 to find the Radio ID of your radio. In addition, the Radio ID is located on the bottom of the SiriusXM Connect Vehicle Tuner and its packaging. You will need this number to activate your subscription. Write the number down for reference.

Note

- The SiriusXM Radio ID does not include the letters I, O, S or F.

To display the SiriusXM Radio ID

1. Press HOME, then touch [SiriusXM].
2. Touch the channel number on the SiriusXM radio screen.
3. Input [000], then touch [OK].

In the USA, you can activate online or by calling SiriusXM Listener Care:

- Visit www.siriusxm.com/activatenow
- Call SiriusXM Listener Care at 1-866-635-2349

For Canadian Subscriptions, please contact:

- Visit www.siriusxm.ca/activate
- Call SiriusXM Customer Care at 1-888-539-7474

As part of the activation process, the SiriusXM satellites will send an activation message to your radio. When your radio detects that the radio has received the activation message, your radio will display: [Subscription Updated. Press Enter to Continue.]. Once subscribed, you can tune to channels in your subscription plan.

Note

- The activation process usually takes 10 to 15 minutes, but may take up to an hour.
- Your radio will need to be turned on and receiving the SiriusXM signal to receive the activation message.

In-Car Receiver
XAV-AX6000/XAV-AX6050

Tuning Channels for SiriusXM

Reception controls/indications

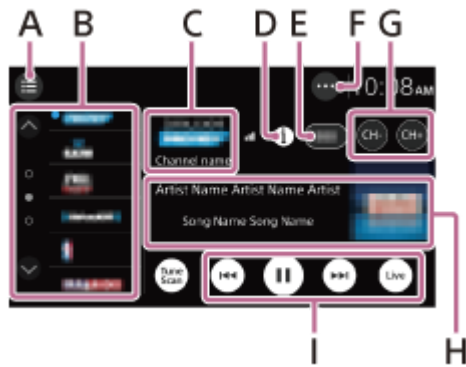

A. ☰ (list)

Open the channel list or category list.

B. Preset numbers

Select a preset channel. Touch / (up/down) to show the other preset channels. Touch and hold to store the current channel in that preset.

C. Channel logo, channel name

D. ⓘ (information)

Switch the channel information in **H**.

E. Channel number

F. ⋮ (SXM option)

Open the SXM option menu.

G. CH- (previous channel) /CH+ (next channel)

Select a channel.

H. Album art, artist name (category name), song title (content information)

I. ▶ (play) / ⏸ (pause), ⏮ (previous) / ⏭ (next), 📺 (Live)

Each feature is compatible with SXV200 or later tuner models.

(Live) is used to go back to live music/content.

You can reverse, forward, pause, and play by using the stored data while receiving the channel. During pause, [Replay Memory Full] may appear on the screen depending on the buffer.

Stored data will be erased when the ACC is OFF and the system is restarted.

In-Car Receiver
XAV-AX6000/XAV-AX6050

Tuning the Channel by Inputting its Channel Number

- 1 Touch the area with the channel number on the SiriusXM radio screen.

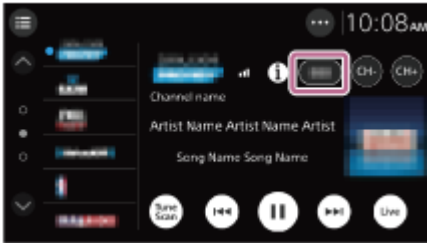

- 2 Input the channel number, then touch [OK].
-

Related Topic



- [Tuning Channels for SiriusXM](#)

In-Car Receiver
XAV-AX6000/XAV-AX6050

Tuning the Channel by TuneScan™

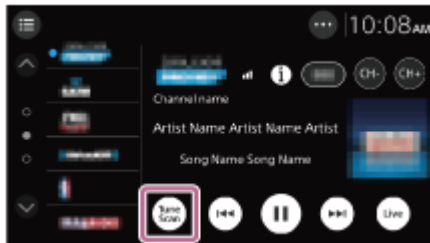
You can use the TuneScan feature to find your favorite music channel.



If you have multiple favorite music channels, you will have a lot of choices each time you tune. Instead of touching every preset channel and listening to the music, you can simply touch  (TuneScan) to get a short preview of music that you have missed on each of your preset music channels. (The six presets shown on the preset list and the currently tuned channel are previewed.) Find your favorite music and touch  (play) to continue listening to the music. You can skip backward or forward if you missed the preview, or you are not interested in the current preview.

Note

- This feature is compatible with SXV200 or later tuner models.
The number of music tracks for TuneScan depends on the SiriusXM tuner condition. TuneScan channels are comprised of preset channels, so it may take a few minutes after power on or preset page change to operate.

In-Car Receiver
XAV-AX6000/XAV-AX6050

Tuning the Channel from the Channel List or Category List

- 1 Touch  (list) on the SiriusXM radio screen.

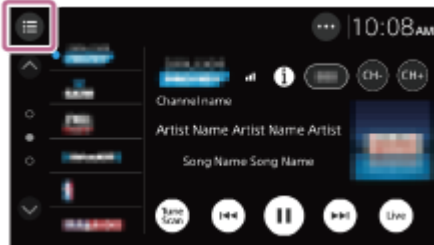

The category list appears.

- 2 Touch the desired category.

To tune from the channel list, touch [All Channels].

- 3 Touch the desired channel.

In-Car Receiver
XAV-AX6000/XAV-AX6050

Setting a Parental Control

The parental control feature allows you to limit access to SiriusXM channels with mature content. When enabled, the parental control feature requires you to enter a passcode to tune to the locked channels. Information on setting up the passcode and locking channels can be found below.

- 1 Touch **•••** (option) on the SiriusXM radio screen, then touch **[Parental Control]**.



The passcode input display appears.

- 2 Enter your 4-digit passcode by touching the number keys, then touch **[OK]**.

The passcode confirmation display appears.

- 3 Enter the 4-digit passcode again, then touch **[OK]**.

The parental control is applied, and the channels are locked.

To unlock the channels/To lock the channels again

1. Touch **•••** (option), then touch **[Parental Control]**.
The passcode input display appears.
2. Enter your 4-digit passcode by touching the number keys, then touch **[OK]**.

To change the passcode

1. Touch **•••** (option), touch **[Change Passcode]**, then enter your current passcode.
2. Enter your new passcode, then touch **[OK]**.
The passcode confirmation display appears.
3. Enter your new passcode again, then touch **[OK]**.

In-Car Receiver
XAV-AX6000/XAV-AX6050

Using SXM Option Functions

The following functions are available by touching ●●● (option) on the SiriusXM radio screen.



[Parental Control]

Sets the parental lock to on or off.

[Change Passcode]

Changes the passcode for the Parental Control feature.

[TuneStart]

Switches the TuneStart™ feature on or off.

When turning the TuneStart feature on, you can listen to the beginning of the music when you tune to one of your preset channels. It may take a minute or two for the feature to work after power up or after changing preset pages.

Note

- This feature is compatible with SXV200 or later tuner models.
You may not listen to the beginning of the music depending on the SiriusXM tuner condition.

Listening to the DAB/DAB+ Radio

Press HOME, then touch [DAB+].

If [DAB+] is not set in the Favorite area, touch [All Apps] to display the HOME2 screen, then select [DAB+].

Hint

- Set [Antenna Power] to [On] (default) or [Off] depending on the type of DAB antenna (aerial) (not supplied).
- When [DAB+] is selected for the first time after performing the factory reset, the Station List starts to update automatically. Allow the Update Station List to finish. (If interrupted, [Update Station List] will start again the next time you select [DAB+].) If no DAB station is stored in the Station List, tune by touching [Update Station List] of the Station List.

Reception controls/indications

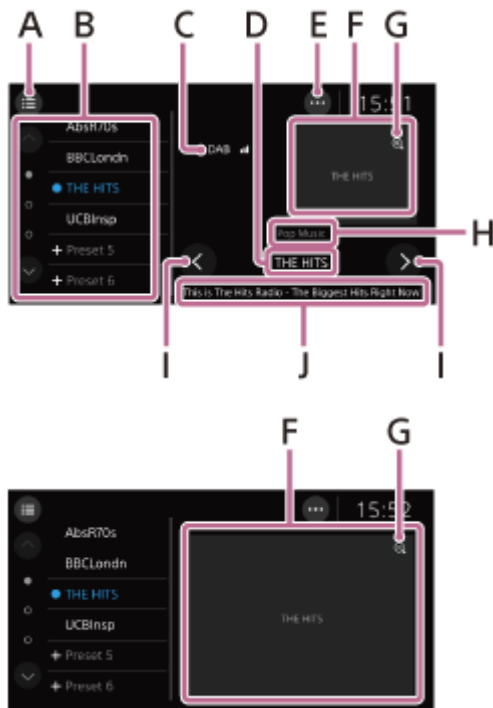

A. (list)

Open the Station List and select a station from the Station List.

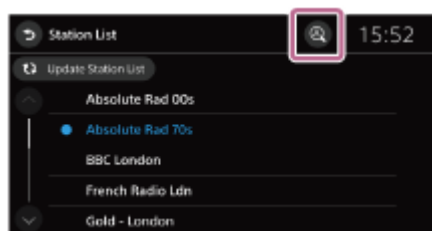

The Station Logo is displayed on the Station List if data is available.

To search the desired station in alphabetical order, touch  (alphabetical search).



B. Preset list

Select a preset station.

Touch  /  (up/down) to show the other preset stations.

Touch and hold to store the current station in that preset.
In the initial state, all preset lists are unregistered.
The Station Logo is displayed if data is available.

C. DAB  (DAB icon)

Indicate the signal strength status of the DAB radio.

D. Station name

E.  (DAB Options)

Open the DAB Options menu.

F. Station Logo / Slideshow area

Display the station name if there is no available Station Logo data or slideshow data.
The picture is enlarged if slideshow data is available.

G.  (zoom out)

Zoom out on the enlarged slideshow, and the station name, program type of the station, and information for the broadcast contents are displayed.

H. Program type of the station

I.  (left/right)

Select previous/next station.

J. Information for the broadcast contents

Related Topic

- [Using DAB Option Functions](#)

In-Car Receiver
XAV-AX6000/XAV-AX6050

Using DAB Option Functions

The following functions are available by touching ●●● (option) on the DAB/DAB+ radio screen.

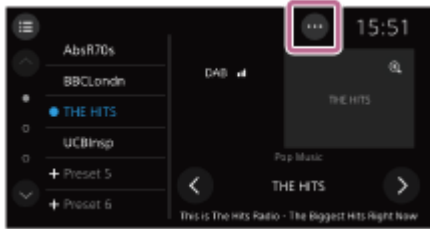

[Announcements]

Enables DAB announcements with interrupting the currently selected source: [On], [Off].
During a DAB announcement, the volume is adjusted to the level set for Traffic Announce in RDS.

[Related Station Link]

Searches for and tunes to the same or similar program automatically when the signal of the current program is too weak to receive: [On], [Off].

Related Station Link	DAB/FM
Off	Follows the same program only
On	Follows the same program and also similar program

[Antenna Power]

Supplies power to the DAB antenna (aerial) input terminal: [On], [Off].

Related Topic

- [Using Radio Option Functions](#)

In-Car Receiver
XAV-AX6000/XAV-AX6050

Playing a USB Device

MSC (Mass Storage Class) type USB devices* compliant with the USB standard can be used.

* e.g., a USB flash drive, digital media player

Note

- Up to 25,000 files can be read for any type of file stored on a USB device.
- Store only the supported file formats for USB playback on a USB device.
- Check the supported file formats for USB playback.

1 Turn down the volume on the unit.

2 Connect the USB device to the USB port.

3 Press HOME, then touch [USB].

If [USB] is not set in the Favorite area, touch [All Apps] to display the HOME2 screen, then select [USB].
Playback starts.

4 Touch  (audio) or  (video) to change the file type.

To remove the USB device



Turn the unit off or turn the ignition switch to the ACC off position, then remove the USB device.

Related Topic

- [Supported Formats for USB Playback](#)
- [Customer Support Websites](#)

In-Car Receiver
XAV-AX6000/XAV-AX6050

Repeat Play and Shuffle Play

- 1 During USB playback, touch  (repeat) or  (shuffle) repeatedly until the desired play mode appears.



Playback in the selected play mode may take time to start.

Available play modes differ depending on the selected sound source and connected device.

In-Car Receiver
XAV-AX6000/XAV-AX6050

Searching for a File from the List Screen

- 1 During USB playback, touch  (list).**

The list screen of the currently played item appears.
Touch  (audio) or  (video) to list up by file type.
- 2 Touch the desired item.**

Playback starts.

In-Car Receiver
XAV-AX6000/XAV-AX6050

Other Settings during Playback

When playing back a video, further settings are available by touching ●●● (option).

Aspect

Selects an aspect ratio for the screen of the unit.

Item	Detail
Full	Displays a 16:9 picture in its original size.
Normal	Displays a 4:3 picture in its original size, with side bars to fill the 16:9 screen.
Zoom	Displays a 16:9 picture that has been converted into 4:3 letter box format.
Captions	Enlarges the picture horizontally, while fitting captions in the screen.

In-Car Receiver
XAV-AX6000/XAV-AX6050

Playing an HDMI™ Device

- 1 Turn off the HDMI device.**
- 2 Turn down the volume on the unit.**
- 3 Connect the HDMI device to the HDMI terminal on the unit.**
- 4 Press HOME, then touch [HDMI].**
If [HDMI] is not set in the Favorite area, touch [All Apps] to display the HOME2 screen, then select [HDMI].
- 5 Turn on the HDMI device.**
Playback starts.

Note

- When using the HDMI connection with your iPhone or Android phone, disconnect the BLUETOOTH connection, Apple CarPlay, and Android Auto.
- Do not disconnect the device during playback.
- To connect an Apple device via the HDMI cable, Lightning Digital AV Adapter or USB-C Digital AV Multiport Adapter is required.
- To charge a device when connecting the HDMI cable, connect to the USB port using a multiport adaptor.
- The supplied remote commander works for some of the operations on the unit. (XAV-AX6000(E)/XAV-AX6000(E17)/XAV-AX6000(IN))
- For HDMI connection, the supplied remote commander only works for this unit. (XAV-AX6000(E)/XAV-AX6000(E17)/XAV-AX6000(IN))
- The image may show up differently on the unit's display compared to the one on the display of the connected HDMI device.
- This unit is compatible with 480p, 576p, and 720p.

In-Car Receiver
XAV-AX6000/XAV-AX6050

Other Settings during Playback

When playing back a video from an HDMI device connected to the HDMI terminal, further settings are available by touching ●●● (option).

Picture EQ

Adjusts the picture quality according to your taste and stores them as custom setting: [Off], [Custom 1], [Custom 2].

 (register/setup) adjusts the contrast level and color level.

(Available only when the parking brake is applied.)

Item	Detail
Contrast	Adjusts the contrast level of the picture EQ: -10 to +10.
Color	Adjusts the color level of the picture EQ: -10 to +10.

In-Car Receiver
XAV-AX6000/XAV-AX6050

Playing a BLUETOOTH Device

You can play contents on a connected device that supports BLUETOOTH A2DP (Advanced Audio Distribution Profile).



1 Make a BLUETOOTH connection with the BLUETOOTH device.

2 Press HOME, then touch [Bluetooth].

If [Bluetooth] is not set in the Favorite area, touch [All Apps] to display the HOME2 screen, then select [Bluetooth].

3 Operate the BLUETOOTH device to start playback.

To match the volume level of the BLUETOOTH device to other sources

You can reduce the volume level differences between this unit and the BLUETOOTH device:
During playback, touch ●●● (option), then set [Bluetooth Input Level] between -6 and +6.

Note

- Depending on the BLUETOOTH device, information such as title, track number/time, and playback status may not be displayed on this unit.
- Depending on the BLUETOOTH device or music playback application, audio output may distort when [Bluetooth Input Level] is set between +1 and +6. In this case, lower the [Bluetooth Input Level].
- BLUETOOTH connection is not possible while Apple CarPlay or Android Auto is running.

Related Topic

- [Connecting with a Paired BLUETOOTH Device](#)

In-Car Receiver
XAV-AX6000/XAV-AX6050

Repeat Play and Shuffle Play

- 1 During playback, touch  (repeat) or  (shuffle) repeatedly until the desired play mode appears.

Playback in the selected play mode may take time to start.

Available play modes differ depending on the selected sound source, connected device, and app.

In-Car Receiver
XAV-AX6000/XAV-AX6050

Preparing a Mobile Phone

To use a mobile phone, connect it with this unit.



Note

- The handsfree calling functions are not available when the Apple CarPlay or Android Auto function is activated. In this case, use the handsfree calling functions of the application.

Related Topic

- [Pairing and Connecting with a Bluetooth® Device](#)
- [Connecting with a Paired BLUETOOTH Device](#)

In-Car Receiver
XAV-AX6000/XAV-AX6050

Receiving a Call

1 Touch  (call) when a call is received.

The phone call starts.

Note

- The ringtone and talker's voice are output from the front speakers. To select the speakers for handsfree calling, press HOME, then touch [Settings] and select [Optional Audio Output Channel] in [System].

To reject/end a call

Touch  (end a call).

Related Topic

- [Preparing a Mobile Phone](#)

Making a Call

1 Press HOME, then touch [Phone].

If [Phone] is not set in the Favorite area, touch [All Apps] to display the HOME2 screen, then select [Phone].

2 Touch one of the call icons on the BLUETOOTH phone display.

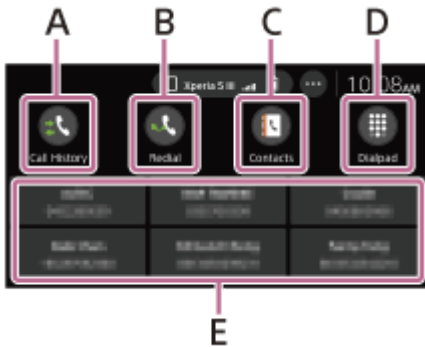

A. 📞 (Call History)*

Select a contact from the call history list. The unit stores the last 20 calls.

B. 📞 (Redial)

Make a call automatically to the last contact you made.

C. 📞 (Contacts)*

Select a contact from the name list/number list. To search for the desired contact in alphabetical order from the name list, touch 🔍 (Alphabetical Search).

D. 📞 (Dialpad)

Enter the phone number.

E. Favorites

Select the stored contact.

To store the contact, see “To add phone numbers to Favorites” below.

* The mobile phone needs to support PBAP (Phone Book Access Profile).

3 Touch 📞 (call).

The phone call starts.

To add phone numbers to Favorites

You can store up to 6 contacts in the Favorites.

1. On the phone screen, touch 📞 (Contacts) and select a phone number you want to store in the Favorites. The confirmation display appears.
2. Touch [Add to Favorites].
3. Touch the desired preset in the Favorites to store the phone number. The contact is stored in the Favorites.

Note

- If the contact's name or phone number is too long, the string ends with "...".

Related Topic

- [Preparing a Mobile Phone](#)

5-035-402-11(6) Copyright 2022 Sony Corporation

In-Car Receiver
XAV-AX6000/XAV-AX6050

Available Operations during a Call

To adjust the ringtone volume

Press VOL (volume) +/- while receiving a call.



To adjust the talker's voice volume

Press VOL (volume) +/- during a call.

To adjust the volume for the other party (Mic gain adjustment)

During a handsfree call, touch ●●● (option), then set [MIC Gain] to [High], [Middle], or [Low].

To switch between handsfree mode and handheld mode

During a call, touch  ↔  (speaker/phone) to switch the phone call audio between the unit and mobile phone.

Note

- Depending on the mobile phone, this operation may not be available.

To answer a receiving call automatically

Touch ●●● (option), then set [Auto Answer] to [On].

You cannot change the settings during a call or while making or receiving a call. It is required to be set in advance.

In-Car Receiver
XAV-AX6000/XAV-AX6050

Getting iDataLink Maestro Ready

Connecting the iDataLink Maestro module (not supplied) to this unit allows you to display the current car status and adjust certain settings.

Available functions and settings differ according to your car type and the firmware installed to the iDataLink Maestro module. For more information, visit the following site:

<https://www.idatalinkmaestro.com/>

Sony does not guarantee all operations of the iDataLink Maestro functions and settings.

Installing the firmware to the iDataLink Maestro module is required before using the iDataLink Maestro features. Update to the latest firmware to use all available functions.

1 Check the serial number of the unit.

The serial number is indicated on the back of the unit, or touch [System Information] in [System].

2 Visit the website.

<https://www.idatalinkmaestro.com/>

Follow the on-screen instructions to configure the firmware according to your car type.

Enter the serial number.

3 Install the firmware to the iDataLink Maestro module.

If you have any questions or problems concerning the iDataLink Maestro module that are not covered on the website, contact:





Automotive Data Solutions Inc.

Email: maestrosupport@adsdata.ca

Call: 1-866-427-2999

In-Car Receiver
XAV-AX6000/XAV-AX6050

Using iDataLink Maestro

After installing the iDataLink Maestro module, only available functions and settings are displayed on the HOME screen:
Ex.,  Climate,  Gauges,  Vehicle Info,  Park Assist

Climate:

You can use this screen to see the status or control the climate control in your car.

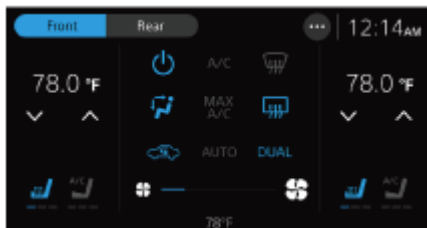

Gauges:

Displays driving information of your car, such as running speed and engine speed.



Vehicle Info:

Displays information from your car, such as the tire pressure and car battery voltage.



Park Assist:

Adds a visual display of detected objects to the existing parking sensor system in your car.

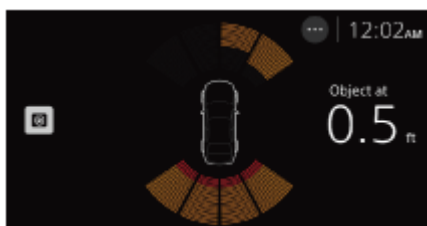

Note on the obstacle detect information

This function is for supporting the driver's vision only, and not all obstacles and risks can be detected.

In-Car Receiver
XAV-AX6000/XAV-AX6050

Basic Setting Operation

You can set items in the following setup categories: Device Connection, Sound, Customize, Application, System.

1 Press HOME, then touch [Settings].

If [Settings] is not set in the Favorite area, touch [All Apps] to display the HOME2 screen, then select [Settings].

2 Touch one of the setup category.

The items that can be set differ depending on the source and settings.

3 Touch the item you want to set.

To return to the previous display

Touch  (back).

Related Topic

- [Device Connection](#)
- [Sound](#)
- [Customize](#)
- [Application](#)
- [System](#)

In-Car Receiver
XAV-AX6000/XAV-AX6050

Device Connection

+Add New Device

- Connects and registers your device to the unit newly.
- Displays the name of the device connected to the unit. If the name of the connected device is duplicated, a suffix such as "-2", "-3", ... will appear after the name.
- You can switch the device by touching the name of the device you want to connect.
- When touching ⓘ, you can perform the following operations.
 - Delete the device by touching [Forget This Device].
 - Disconnect the device by touching [Disconnect].
 - When connecting an iPhone compatible with Apple CarPlay, you can switch between the BLUETOOTH connection and Apple CarPlay by touching [Change to Bluetooth] or [Change to Apple CarPlay].
 - When connecting an Android phone compatible with Android Auto, you can switch between the BLUETOOTH connection and Android Auto by touching [Switch to Bluetooth] or [Start Android Auto].

Note

- When pairing your BLUETOOTH device and the unit, be sure to open this setting.

Related Topic

- [Basic Setting Operation](#)

Sound

EQ

Selects an equalizer curve.
(Available when any source is selected.)

Item	Detail
EQ	<p>Selects the equalizer curve:</p> <p>XAV-AX6000(UC) [Off], [R&B], [Rock], [Pop], [Dance], [Hip-Hop], [EDM], [Jazz], [Soul], [Country], [Custom 1], [Custom 2]</p> <p>XAV-AX6000(E)/XAV-AX6000(E17) [Off], [R&B], [Rock], [Pop], [Dance], [Hip-Hop], [Jazz], [Soul], [Regueton], [Salsa], [Custom 1], [Custom 2]</p> <p>XAV-AX6000(IN) [Off], [Bollywood], [R&B], [Rock], [Pop], [Dance], [Hip-Hop], [EDM], [Jazz], [Regueton], [Custom 1], [Custom 2]</p> <p>XAV-AX6050(EUR) [Off], [R&B], [Rock], [Pop], [Dance], [Hip-Hop], [EDM], [Jazz], [Soul], [Country], [Custom 1], [Custom 2]</p>
Edit Custom EQ	<p>Adjusts the equalizer curve from -12 to +12. When touching [EQ Adjust] of [EQ], [Edit Custom EQ] appears. The adjusted curve can be saved to [Custom 1] or [Custom 2] by touching [Save].</p> 

Subwoofer Level

Adjusts the volume level of the subwoofer: [Off], [On], -10 to +10.

Balance/Fader

Adjusts the balance/fader level.

Item	Detail
Balance	Adjusts the sound balance between the left and right speakers: [L15] to [R15].
Fader	Adjusts the sound balance between the front and rear speakers: [Front 15] to [Rear 15].

Listening Position

Selects the listening position: [Front Left], [Front Right], [Front], [All], [Off], [Custom].

You can adjust the position of the sound image by correcting the arrival time of the sound according to the sitting position of the car. When selecting [Custom], [Time Alignment] appears. You can adjust the distance from each speaker to the listening position in 0.1 inch or 1 cm increments (unit switchable) to correct the time it takes for the sound to reach the listening position.



Crossover

Adjusts the cut-off frequency, slope, and subwoofer phase.

Item	Detail
High Pass Filter	Adjusts the cut-off frequency of the front/rear speakers.
Low Pass Filter	Selects the cut-off frequency of the subwoofer.
Slope	Adjusts the slope of the front/rear speakers and subwoofer.
Phase	Selects the subwoofer phase: [Normal], [Reverse].

Related Topic

- [Basic Setting Operation](#)

In-Car Receiver
XAV-AX6000/XAV-AX6050

Customize

Custom Button

Registers functions: [Mute/Disp. Off], [Source Change].

Select Home Clock Display

Changes the clock on the HOME screen: [Analog Face], [Digital Face], [No Center Clock].

Wallpaper Select

Changes the wallpaper by touching the desired color or sets your favorite photo data in a MSC (Mass Storage Class) type USB device as a wallpaper.

(Available only when photo data are JPEG files of 6 MB or less with a pixel size of 2048 × 1080 or less.)

To set a photo data

When connecting the USB device to the USB port, touch [+] to display photos. Select your favorite photo, then touch [OK].

Related Topic

- [Basic Setting Operation](#)

In-Car Receiver
XAV-AX6000/XAV-AX6050

Application

Camera Display

[Rear Camera View] selects a camera view mode: [Normal], [Flipped].

[Rear Camera Interruption] displays the video of the rear view camera connected to the REAR CAMERA IN cable when you put the gear shift in R (reverse).

[Rear Camera Guideline Adjust] displays the rear camera guidelines.

Note on connecting the iDataLink Maestro module (not supplied) (XAV-AX6000(UC))

When connecting the iDataLink Maestro module (not supplied) and you are using the Backup Camera Dynamic Guidelines function, adjust the guideline.

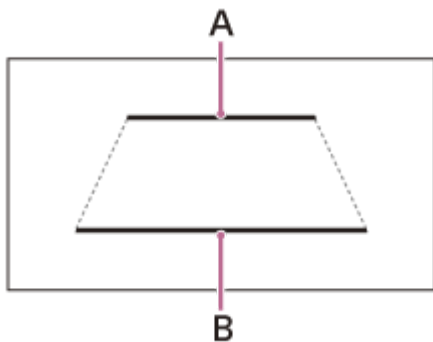

A. 2.0 m (6 1/2 feet) behind the car

B. 0.5 m (1 3/4 feet) behind the car

SXM Reset (XAV-AX6000(UC))

Initializes the SiriusXM Connect Vehicle Tuner settings: [Reset], [Cancel].

Maestro Input Level (XAV-AX6000(UC))

Adjusts the relative volume level to the signal input from the iDataLink Maestro module: -8 to +8.

(Available only when the connection with iDataLink Maestro is established.)

Maestro Settings (XAV-AX6000(UC))

Displays the menus for your original car settings and setting for the iDataLink Maestro module. Your display will vary based on the firmware in the iDataLink Maestro module.

(Available only when the connection with iDataLink Maestro is established.)

Radio Tuning Steps (XAV-AX6000(E)/XAV-AX6000(E17)/XAV-AX6000(IN)/XAV-AX6050(EUR))

Sets the FM/AM tuning step of your country or region.(XAV-AX6000(E)/XAV-AX6000(E17)/XAV-AX6000(IN))

Sets only the FM tuning step of your country or region.(XAV-AX6050(EUR))

Note

- When changing the FM tuning step, both FM and AM preset stations are reset. (XAV-AX6050(EUR))

Related Topic

- [Basic Setting Operation](#)

5-035-402-11(6) Copyright 2022 Sony Corporation

In-Car Receiver
XAV-AX6000/XAV-AX6050

System

Language

Selects the display language: [Deutsch], [English], [Español], [Français], [Indonesian], [Italiano], [Nederlands], [Português], [Русский], [العربية], [简体中文], [繁體中文], [한국어].

Date/Time

When receiving the GPS signal before setting [Date/Time], [Date/Time] is set automatically.

Item	Detail
Date	Sets the date: [Month], [Day], [Year].
Time	Sets the clock time: [Hour], [Minute], [AM/PM].
Date Format	Selects the format: [DD-MM-YYYY], [MM-DD-YYYY], [YYYY-MM-DD].
Time Format	Selects the format: [12-Hour], [24-Hour].

Demo Mode

Activates or deactivates the demonstration.

Steering Wheel Settings

Selects the input mode for the connected remote control. To prevent a malfunction, be sure to match the input mode with the connected remote control before use.

Set the [Custom] switch to [On].



Note

- While making settings, the connected remote control cannot be used even though some functions have already been registered. Use the buttons on the unit.
- This function may not be available on some vehicles. For details on the compatibility of your vehicle, visit the support site.

System Sound

Activates or deactivates the operation sound.

Volume Settings

Adjusts the volume level of each source.

Item	Detail
Media	Adjusts the volume of media: 0 to 50.
Radio Announcements (XAV-AX6050(EUR))	Adjusts the volume of radio announcements: 0 to 50.
Phone Call	Adjusts the volume of phone calls: 0 to 50.
Ring Tone	Adjusts the volume of the ring tone: 0 to 50.
Voice Recognition	Adjusts the volume of voice recognition: 0 to 50.
Maestro Chime (XAV-AX6000(UC))	Adjusts the volume of Maestro chime: 0 to 50. (Available only when the connection with iDataLink Maestro is established.)
Navigation Guidance	Adjusts the volume of navigation guidance from Apple CarPlay or Android Auto: 0 to 50.

Note

- When adjusting the volume settings, park your car in a safe place as it may be too loud to hear the surrounding sounds.

Optional Audio Output Channel

Selects the channels for call, guidance, and prompt audio: [Front], [Rear].

Dimmer

Adjusts the brightness level of the display and buttons by changing the value.

When [Activate the set value with the vehicle's light] is on, the display and buttons turn on at this brightness level when the head lights are turned on.

Key Illumination

Dims the button illumination: [Off], [On].

Key Brightness on Display Off

Dims the button brightness when the monitor is turned off: [Off], [1], [2], [3], [4].

Driver's Position

Selects the driving position to optimize usability of Apple CarPlay and Android Auto: [Left Side], [Right Side].

MIC Adjust

Sets the microphone parameters according to the size of the car: [Small Cabin], [Medium Cabin], [Large Cabin].

Bluetooth Signal

Activates the BLUETOOTH signal: [Off], [On].

Change PSK

Changes the Wi-Fi pass key.

System Information

Displays the system information: [Software Version], [Serial Number], [Wi-Fi Status], [Bluetooth Status], [GPS Status], [Speed Sensor Status].

Software Update

Updates the software via USB flash drive or USB tethering.

Factory Reset

Initializes all the settings to the factory settings.

Open Source Licenses

Displays the software licenses.

Related Topic

- [Basic Setting Operation](#)

In-Car Receiver
XAV-AX6000/XAV-AX6050

Canceling the Demonstration Mode

1 Press **HOME**, then touch **[Settings]**.

If **[Settings]** is not set in the Favorite area, touch **[All Apps]** to display the HOME2 screen, then select **[Settings]**.

2 Touch **[System]**, then touch **[Demo Mode]** to set to **[Off]**.

3 To exit the setup menu, touch  (back) twice.

Related Topic

- [System](#)

In-Car Receiver
XAV-AX6000/XAV-AX6050

Sorting Apps on the Apps Area (Favorite)

Up to 5 Apps can be set on the Apps area (Favorite) of the HOME1 screen. Five Apps can be sorted.
Touch and hold the App you want to move, then drag it to the place you want to set it to.
Apps on the Apps area (Favorite) can be also changed to Apps on the Apps area except for those set to Favorite.

HOME1 screen

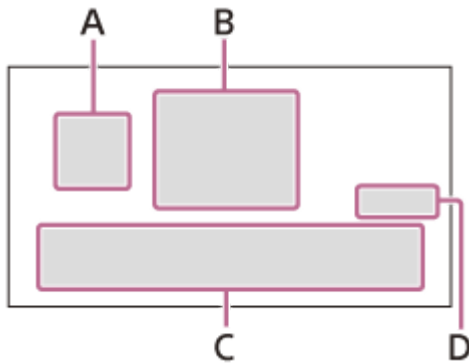

HOME2 screen

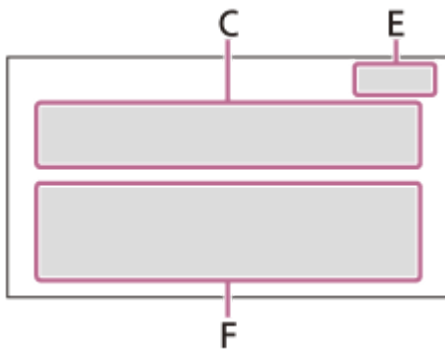

- A. (Apple CarPlay)/ (Android Auto)
- B. Clock
- C. Apps area (Favorite)
- D. All Apps
- E. Close
- F. Apps area (except for those set to Favorite)

To change an App on the Apps area (Favorite)

- 1 Touch [All Apps] to open the HOME2 screen.
The HOME2 screen opens.
- 2 Touch and hold the App to move from the Apps area (Favorite), then drag it to the Apps area (except for Favorite).
A blank is created on the Apps area (Favorite).
- 3 Touch and hold the App to move to the App area (Favorite), then drag it on the blank space of the Apps area (Favorite).

4 Touch [Close] to return to the HOME1 screen.

Note

- When you want to insert or move the App to the App area (Favorite), make sure the HOME2 screen opens. You cannot insert or move the Apps on the HOME1 screen.
- Apps on the Apps area (Favorite) are not aligned automatically. The blank between Apps is maintained.
- Apps except for the Apps area (Favorite) are aligned automatically. The blank between Apps is not created.

Related Topic

- [Screen Displays](#)

5-035-402-11(6) Copyright 2022 Sony Corporation

In-Car Receiver
XAV-AX6000/XAV-AX6050

Updating the Software

To update the software, visit the support site, then follow the online instructions.

To update the software with a USB flash drive

Download the software from the support site and save it in your USB flash drive. Connect your USB flash drive to the USB port, then follow the instructions on the screen of the unit.

To update the software with USB tethering mode

When using the smartphone with tethering function, you can update the software with USB tethering mode. Connect your smartphone to the USB port, then follow the instructions on the screen of the unit.

Note

- During the update with a USB connection, do not disconnect the USB cable or USB device.
- A network connection may be required, and high packet communication fees may be incurred.

Related Topic

- [Customer Support Websites](#)

In-Car Receiver
XAV-AX6000/XAV-AX6050

Precautions

- Power antenna (aerial) extends automatically.
- When you transfer ownership or dispose of your car with the unit installed, initialize all the settings to the factory settings by performing the factory reset.
- Do not splash liquid onto the unit.

Notes on safety

- Comply with your local traffic rules, laws, and regulations.
- While driving
 - Do not watch or operate the unit, as it may lead to distraction and cause an accident. Park your car in a safe place to watch or operate the unit.
 - Do not use the setup feature or any other function which could divert your attention from the road.
 - When backing up your car, be sure to look back and watch the surroundings carefully for your safety even if the rear view camera is connected. Do not depend on the rear view camera exclusively.
- While operating
 - Do not insert your hands, fingers, or foreign objects into the unit as it may cause injury or damage to the unit.
 - Keep small articles out of the reach of children.
 - Be sure to fasten seatbelts to avoid injury in the event of sudden movement of the car.

Preventing an accident

Do not operate the unit or watch the monitor while driving.

Pictures appear only after you park the car and set the parking brake. If the car starts moving during video playback, the following caution is displayed and you cannot watch the video.

[Video blocked for your safety]

Notes on LCD panel

- Do not get the LCD panel wet or expose it to liquids. This may cause a malfunction.



- Do not press down hard on the LCD panel as doing so can distort the picture or cause a malfunction (i.e., the picture may become unclear or the LCD panel may be damaged).
- Do not touch the panel with objects other than with your finger as it may damage or break the LCD panel.
- Clean the LCD panel with a dry soft cloth. Do not use solvents such as benzene, thinner, commercially available cleaners, or antistatic spray.
- Do not use the unit outside the temperature range 0 °C to 40 °C (32 °F to 104 °F).
- If your car was parked in a cold or hot place, the picture may not be clear. However, the monitor is not damaged and the picture will become clear after the temperature in your car becomes normal.

- Some stationary blue, red, or green dots may appear on the monitor. These are called “bright spots” and can happen with any LCD. The LCD panel is precision-manufactured with more than 99.99% of its segments functional. However, it is possible that a small percentage (typically 0.01%) of the segments may not light up properly. This will not, however, interfere with your viewing.

Notes on the touch screen

- This unit uses a capacitive touch screen. Touch the screen directly with your fingertip.
- Multi-touch operation is not supported on this unit.
- Do not touch the screen with sharp objects such as a needle, pen, or fingernail. Operation with a stylus is not supported on this unit.
- Touching the screen with a gloved finger may cause the unit to operate incorrectly or not respond.
- Do not let any objects contact the touch screen. If the screen is touched by an object other than your fingertip, the unit may not respond correctly.
- Since glass material is used for the screen, do not subject the unit to strong shock. If cracking or chipping occurs on the screen, do not touch the damaged part as it may cause injury.
- Keep other electrical devices away from the touch screen. They may cause the touch screen to malfunction.
- If there are water droplets on the touch screen, or if you touch the screen with wet fingertips, the touch screen may not react correctly.

Internet connection and IP address

Technical data such as IP address (or device details) is used when this product is connected to the internet for software update or receiving third party services. For software updates, these technical data may be communicated to our update servers in order to provide you with the software update appropriate to your device. If you do not want such technical data be used at all, do not set-up the wireless internet function and do not connect an internet cable.

If you have any questions or problems concerning your unit that are not covered in this Help Guide, consult your nearest Sony dealer.

In-Car Receiver
XAV-AX6000/XAV-AX6050

Supported Formats for USB Playback

Audio:

WMA (.wma)*¹ *²

Bit rate: 32 kbps – 192 kbps (Supports variable bit rate (VBR))*³
Sampling frequency*⁴: 44.1 kHz
Channel number : 2ch

MP3 (.mp3)*¹ *²

Bit rate: 32 kbps – 320 kbps (Supports variable bit rate (VBR))*³
Sampling frequency*⁴: 32 kHz, 44.1 kHz, 48 kHz
Channel number: 2ch

AAC (.m4a)*¹ *²

Bit rate: 16 kbps – 320 kbps (Supports variable bit rate (VBR))*³
Sampling frequency*⁴: 8 kHz – 48 kHz
Channel number: 2ch

ALAC (.m4a)*¹ *⁵

Sampling frequency*⁴: 8 kHz – 384 kHz
Bit per sample (Quantization bit): 16 bits, 24 bits
Channel number: 2ch

FLAC (.flac)*¹

Sampling frequency*⁴: 8 kHz – 384 kHz
Bit per sample (Quantization bit): 16 bits, 24 bits
Channel number: 2ch

WAV (.wav)*¹

Sampling frequency*⁴: 8 kHz – 768 kHz
Bit per sample (Quantization bit): 16 bits, 24 bits, 32 bits
Channel number: 2ch

DSD (.dsf/.dff)*⁶

Sampling frequency: 2.8 MHz, 5.6 MHz, 11.2 MHz, 22.4 MHz
Channel number: 2ch

Video:

ASF (.asf) / WMV (.wmv)

Video codec: VC-1 Simple/Main/Advanced Profile
Audio codec: WMA
Bit rate: Max. 15 Mbps
Frame rate: Max. 30 fps
Resolution: Max. 1280 × 720

AVI (.avi) / MKV (.mkv) / MPEG-4 (.mp4)

- Video codec: AVC Baseline/Main/High Profile
Audio codec: MP3, AAC
Bit rate: Max. 30 Mbps
Frame rate: Max. 30 fps
Resolution: Max. 1920 × 1080
- Video codec: MPEG-4 Advanced Simple Profile
Audio codec: MP3, AAC
Bit rate: Max. 20 Mbps
Frame rate: Max. 30 fps
Resolution: Max. 1280 × 720

*1 Copyright-protected files and multi-channel audio files cannot be played back.

*2 DRM (Digital Rights Management) files cannot be played back.

*3 Non-standard bit rates or non-guaranteed bit rates are included depending on the sampling frequency.

*4 Sampling frequency may not correspond to all encoders.

*5 Displaying the tag information is not supported.

*6 Converted to PCM internally (192 kHz).

Note

- Not all files of the above file formats can be played back on the unit.
- AVCHD format is not supported.

In-Car Receiver
XAV-AX6000/XAV-AX6050

About iPhone

- **Compatible iPhone models:**

iPhone 13 Pro Max, iPhone 13 Pro, iPhone 13, iPhone 13 mini, iPhone 12 Pro Max, iPhone 12 Pro, iPhone 12, iPhone 12 mini, iPhone SE (2nd generation), iPhone 11 Pro Max, iPhone 11 Pro, iPhone 11, iPhone XS Max, iPhone XS, iPhone XR, iPhone X, iPhone 8 Plus, iPhone 8, iPhone 7 Plus, iPhone 7, iPhone SE, iPhone 6s Plus, iPhone 6s, iPhone 6 Plus, iPhone 6, iPhone 5s

- Use of the Made for Apple badge means that an accessory has been designed to connect specifically to the Apple product(s) identified in the badge, and has been certified by the developer to meet Apple performance standards. Apple is not responsible for the operation of this device or its compliance with safety and regulatory standards. Please note that the use of this accessory with an Apple product may affect wireless performance.
- Check the Apple CarPlay website for supported iOS versions. Update to the latest iOS version before use.

In-Car Receiver
XAV-AX6000/XAV-AX6050

Notice on License

This product contains software that Sony uses under a licensing agreement with the owner of its copyright. We are obligated to announce the contents of the agreement to customers under requirement by the owner of copyright for the software. For details on software licenses, select [Settings] → [System] → [Open Source Licenses].

Notice on GNU GPL/LGPL applied software

The software included in this product contains copyrighted software that is licensed under the GPLv2 and other licenses which may require access to source code. You may find a copy of the relevant source code as required under the GPLv2 (and other licenses) at

<http://www.sony.net/Products/Linux/>.

To download, please access the URL, then select the model name "XAV-AX6000" or "XAV-AX6050". You may obtain the source code as required by the GPLv2 on a physical medium from us for a period of three years after our last shipment of this product by applying through the form at

<http://www.sony.net/Products/Linux/>.

This offer is valid to anyone in receipt of this information.

Please note that Sony cannot answer or respond to any inquiries regarding the content of the source code.

Related Topic

- [System](#)

In-Car Receiver
XAV-AX6000/XAV-AX6050

Maintenance

Replacing the lithium battery (CR2025) of the remote commander (XAV-AX6000(E)/XAV-AX6000(E17)/XAV-AX6000(IN))

When the battery becomes weak, the range of the remote commander becomes shorter.

CAUTION

Danger of explosion if battery is incorrectly replaced. Replace only with the same or equivalent type.

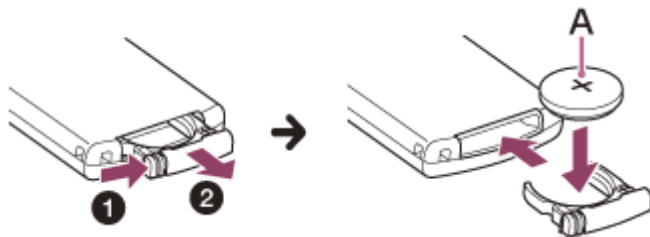

A: Lithium battery (CR2025) + side up

Note

- Keep the lithium battery out of the reach of children. Should the battery be swallowed, immediately consult a doctor.

In-Car Receiver
XAV-AX6000/XAV-AX6050

Specifications

FOR THE CUSTOMERS IN THE USA. NOT APPLICABLE IN CANADA, INCLUDING IN THE PROVINCE OF QUEBEC.

POUR LES CLIENTS AUX ÉTATS-UNIS. NON APPLICABLE AU CANADA, Y COMPRIS LA PROVINCE DE QUÉBEC.

AUDIO POWER SPECIFICATIONS



CTA2006 Standard

Power Output: 20 Watts RMS × 4 Channels at 4 Ohms and ≤ 1% THD+N

Signal to Noise Ratio: 80 dBA (reference: 1 Watt into 4 Ohms)

Monitor section

Display type	Wide LCD color monitor
Dimensions	17.6 cm/ 6.95 in
System	TFT active matrix
Number of pixels	1,152,000 pixels (800 × 3 (RGB) × 480)

Radio section

XAV-AX6000(UC):

FM

Tuning range	87.5 MHz — 107.9 MHz
Usable sensitivity	7 dBf
Signal-to-noise ratio	70 dB (mono)
Separation at 1 kHz	45 dB

AM

Tuning range	530 kHz — 1,710 kHz
Sensitivity	32 μV

XAV-AX6000(E)/XAV-AX6000(E17)/XAV-AX6000(IN):

FM

Tuning range	87.5 MHz — 108.0 MHz (at 50 kHz step) 87.5 MHz — 108.0 MHz (at 100 kHz step)
FM tuning step	50 kHz/100 kHz switchable
Usable sensitivity	7 dBf
Signal-to-noise ratio	70 dB (mono)
Separation at 1 kHz	45 dB

AM

Tuning range	531 kHz — 1,602 kHz (at 9 kHz step) 530 kHz — 1,710 kHz (at 10 kHz step)
AM tuning step	9 kHz/10 kHz switchable
Sensitivity	32 μ V

XAV-AX6050(EUR):**DAB/DAB+**

Tuning range	174.928 MHz — 239.200 MHz
Antenna (aerial) terminal	External antenna (aerial) connector

FM

Tuning range	87.5 MHz — 108.0 MHz (at 50 kHz step) 87.5 MHz — 108.0 MHz (at 100 kHz step)
FM tuning step	50 kHz/100 kHz switchable
Usable sensitivity	7 dBf
Signal-to-noise ratio	70 dB (mono)
Separation at 1 kHz	45 dB

AM

Tuning range	531 kHz — 1,602 kHz
Sensitivity	32 μ V

USB player section

Interface	USB Type-C® (Hi-speed)
Maximum current	USB port: 3.0 A

HDMI section*

Input format	480p, 576p, 720p
--------------	------------------

* HDMI output is not available.

BLUETOOTH section

Communication System	BLUETOOTH Standard version 5.0
Output	BLUETOOTH Standard Power Class 1 (Max. Conducted +7.5 dBm)
Maximum communication range* ¹	Line of sight approx. 10 m (33 ft)
Frequency band	2.4 GHz band (2.4000 GHz — 2.4835 GHz)
Modulation method	FHSS
Compatible BLUETOOTH Profiles* ²	A2DP (Advanced Audio Distribution Profile) 1.3.1 AVRCP (Audio Video Remote Control Profile) 1.6.1 HFP (Handsfree Profile) 1.7.1 PBAP (Phone Book Access Profile) 1.2
Corresponding codec	SBC, AAC, LDAC™

*¹ The actual range will vary depending on factors such as obstacles between devices, magnetic fields around a microwave oven, static electricity, reception sensitivity, antenna (aerial) performance, operating system, software application, etc.

*² BLUETOOTH standard profiles indicate the purpose of BLUETOOTH communication between devices.

Wi-Fi section

XAV-AX6000(UC):

Compatible standards	IEEE802.11 a/n/ac
Radio frequency	5 GHz band (5.725 GHz — 5.850 GHz)
Output power	Max. conducted 16 dBm
Frequency Tolerance	20 ppm

XAV-AX6000(E):

Compatible standards	IEEE802.11 b/g/n
Radio frequency	2.4 GHz band (2.401 GHz — 2.473 GHz)
Output power	Max. conducted 18 dBm
Frequency Tolerance	20 ppm

XAV-AX6000(E17)/XAV-AX6000(IN):

Compatible standards	IEEE802.11 a/n/ac
Radio frequency	5 GHz band (5.725 GHz — 5.850 GHz)
Output power	Max. conducted 10 dBm
Frequency Tolerance	20 ppm

XAV-AX6050(EUR):

Compatible standards	IEEE802.11 a/n/ac
Radio frequency	5 GHz band (5.725 GHz — 5.850 GHz)
Output power	Max. conducted 10 dBm
Frequency Tolerance	20 ppm

Power amplifier section

Outputs	Speaker outputs
Speaker impedance	4 Ω — 8 Ω
Maximum power output	55 W \times 4 (at 4 Ω)

General

Power requirements	12 V DC car battery (negative ground (earth))
Rated current consumption	10 A
Dimensions (maximum)	Approx. 178 mm \times 100 mm \times 132 mm (7 1/8 in \times 4 in \times 5 1/4 in) (w/h/d)
Mounting dimensions	Approx. 182 mm \times 111 mm \times 115 mm (7 1/4 in \times 4 3/8 in \times 4 5/8 in) (w/h/d)
Mass	Approx. 1.0 kg (2 lb 4 oz)
Package contents	Main unit (1) Parts for installation and connections (1 set) Remote commander (1): RM-X400 (XAV-AX6000(E)/XAV-AX6000(E17)/XAV-AX6000(IN))
Optional accessories/equipment	Remote commander: RM-X400 (XAV-AX6000(UC)) SiriusXM Connect Vehicle Tuner*: SXV100, SXV200, SXV300 (XAV-AX6000(UC)) iDataLink Maestro RR module, iDataLink Maestro RR2 module (XAV-AX6000(UC))

* Some features are compatible with SXV200 or later tuner models.

Ask the dealer for detailed information.

Design and specifications are subject to change without notice.

In-Car Receiver
XAV-AX6000/XAV-AX6050

Copyrights



SiriusXM-Ready® allows you to Listen to ad-free music, plus all the sports, talk, comedy, news coverage, all in one place. (SiriusXM Connect Tuner and subscription required. Sold separately.)

For more information, visit www.siriusxm.com.

SiriusXM and all related marks and logos are trademarks of Sirius XM Radio, Inc. All rights reserved.

The Bluetooth® word mark and logos are registered trademarks owned by Bluetooth SIG, Inc. and any use of such marks by Sony Group Corporation and its subsidiaries is under license. Other trademarks and trade names are those of their respective owners.

Windows Media is either a registered trademark or trademark of Microsoft Corporation in the United States and/or other countries.

This product is protected by certain intellectual property rights of Microsoft Corporation. Use or distribution of such technology outside of this product is prohibited without a license from Microsoft or an authorized Microsoft subsidiary.

Apple, iPhone, and Apple CarPlay are trademarks of Apple Inc., registered in the U.S. and other countries.

iOS is a trademark or registered trademark of Cisco in the U.S. and other countries and is used under license.

Google, Android, Google Play and Android Auto are trademarks of Google LLC.

To use Android Auto on your car display, you'll need an Android phone running Android 8 or higher, an active data plan, and the Android Auto app.

To wirelessly use Android Auto on your car display, you need a compatible Android smartphone with an active data plan. You can check which smartphones are compatible at g.co/androidauto/requirements.

The Wi-Fi CERTIFIED™ Logo is a certification mark of Wi-Fi Alliance®.

LDAC and LDAC logo are trademarks of Sony Corporation.

USB Type-C® and USB-C® are registered trademarks of USB Implementers Forum.

The terms HDMI, HDMI High-Definition Multimedia Interface, HDMI Trade dress and the HDMI Logos are trademarks or registered trademarks of HDMI Licensing Administrator, Inc.

THIS PRODUCT IS LICENSED UNDER THE MPEG-4 VISUAL PATENT PORTFOLIO LICENSE FOR THE PERSONAL AND NON-COMMERCIAL USE OF A CONSUMER FOR.

(i) ENCODING VIDEO IN COMPLIANCE WITH THE MPEG-4 VISUAL STANDARD ("MPEG-4 VIDEO") AND/OR

(ii) DECODING MPEG-4 VIDEO THAT WAS ENCODED BY A CONSUMER ENGAGED IN A PERSONAL AND NON-COMMERCIAL ACTIVITY AND/OR WAS OBTAINED FROM A VIDEO PROVIDER LICENSED TO PROVIDE MPEG-4 VIDEO.

NO LICENSE IS GRANTED OR SHALL BE IMPLIED FOR ANY OTHER USE. ADDITIONAL INFORMATION INCLUDING THAT RELATING TO PROMOTIONAL, INTERNAL AND COMMERCIAL USES AND LICENSING MAY BE OBTAINED FROM MPEG LA, L.L.C. [HTTP://WWW.MPEGLA.COM](http://WWW.MPEGLA.COM)

THIS PRODUCT IS LICENSED UNDER THE AVC PATENT PORTFOLIO LICENSE FOR THE PERSONAL USE OF A CONSUMER OR OTHER USES IN WHICH IT DOES NOT RECEIVE REMUNERATION TO

- (i) ENCODE VIDEO IN COMPLIANCE WITH THE AVC STANDARD (“AVC VIDEO”) AND/OR
- (ii) DECODE AVC VIDEO THAT WAS ENCODED BY A CONSUMER ENGAGED IN A PERSONAL ACTIVITY AND/OR WAS OBTAINED FROM A VIDEO PROVIDER LICENSED TO PROVIDE AVC VIDEO.

NO LICENSE IS GRANTED OR SHALL BE IMPLIED FOR ANY OTHER USE. ADDITIONAL INFORMATION MAY BE OBTAINED FROM MPEG LA, L.L.C. SEE [HTTP://WWW.MPEGLA.COM](http://www.mpegla.com)

THIS PRODUCT IS LICENSED UNDER THE VC-1 PATENT PORTFOLIO LICENSE FOR THE PERSONAL AND NON-COMMERCIAL USE OF A CONSUMER FOR

- (i) ENCODING VIDEO IN COMPLIANCE WITH THE VC-1 STANDARD (“VC-1 VIDEO”) AND/OR
- (ii) DECODING VC-1 VIDEO THAT WAS ENCODED BY A CONSUMER ENGAGED IN A PERSONAL AND NON-COMMERCIAL ACTIVITY AND/OR WAS OBTAINED FROM A VIDEO PROVIDER LICENSED TO PROVIDE VC-1 VIDEO.

NO LICENSE IS GRANTED OR SHALL BE IMPLIED FOR ANY OTHER USE. ADDITIONAL INFORMATION INCLUDING THAT RELATING TO PROMOTIONAL, INTERNAL AND COMMERCIAL USES AND LICENSING MAY BE OBTAINED FROM MPEG LA, L.L.C. [HTTP://WWW.MPEGLA.COM](http://www.mpegla.com)

All other trademarks are trademarks of their respective owners.

5-035-402-11(6) Copyright 2022 Sony Corporation

In-Car Receiver
XAV-AX6000/XAV-AX6050

Troubleshooting

Do the following before you request a repair service.

- Read the relevant instruction and troubleshooting topics in this Help Guide.
- Issues may be resolved by updating the software. When you install the “Support by Sony” app on your smartphone, you can get software update information conveniently.
- Visit our customer support home page.

If none of the above works, consult your nearest Sony dealer.

Related Topic

- [Customer Support Websites](#)
- [About the “Support by Sony” App](#)

In-Car Receiver
XAV-AX6000/XAV-AX6050

There is no beep sound.

- System sound is off in settings.

In-Car Receiver
XAV-AX6000/XAV-AX6050

The fuse has blown. / The unit makes noise when the position of the ignition is switched.

-
- The power supply leads are not matched correctly with the car's accessory power connector.

In-Car Receiver
XAV-AX6000/XAV-AX6050

The display disappears from the monitor. / The display does not appear on the monitor.

- The monitor off function is activated.
 - Touch anywhere on the display to turn the display back on.
 - Press DISP OFF on the remote commander. (XAV-AX6000(E)/XAV-AX6000(E17)/XAV-AX6000(IN))
 - The standby function is activated.
 - Press HOME.
-

Related Topic

- [Main Unit and Remote Commander](#)
- [Screen Displays](#)

In-Car Receiver
XAV-AX6000/XAV-AX6050

Menu items cannot be selected.

- Unavailable menu items are displayed in gray.

In-Car Receiver
XAV-AX6000/XAV-AX6050

The unit cannot be operated.

- Press and hold HOME for more than 10 seconds to restart the unit.

In-Car Receiver
XAV-AX6000/XAV-AX6050

The touch screen does not react to your touch correctly.

- Touch one part of the touch screen at a time. If two or more parts are touched simultaneously, the touch screen will not react correctly.
- Touch the pressure sensitive screen firmly.
- The touch screen does not react when touching with a wet fingertip or when water droplets are on the touch screen.
 - Dry your wet fingertips well, or fully wipe water droplets off of the touch screen.

In-Car Receiver
XAV-AX6000/XAV-AX6050

Multi-touch is not recognized.

- Multi-touch operation is not supported on this unit.

In-Car Receiver
XAV-AX6000/XAV-AX6050

A suffix such as “-2”, “-3”, ... appears after the name of the device on [Device Connection].

- The name of the connected device is duplicated. Change the name of the connected device.

In-Car Receiver
XAV-AX6000/XAV-AX6050

The radio reception is poor. / Static noise occurs.

- Connect the antenna (aerial) firmly.
- Connection to REM OUT may be required.

In-Car Receiver
XAV-AX6000/XAV-AX6050

The stations cannot be received. (XAV-AX6000(E)/XAV-AX6000(E17)/XAV-AX6000(IN)/XAV-AX6050(EUR))

- The tuning step setting has been erased.
 - Set the tuning step again.
-

Related Topic

- [Application](#)

In-Car Receiver
XAV-AX6000/XAV-AX6050

Stations cannot be received.

- See [No Station] for details when the DAB signal cannot be received.
-
-

Related Topic

- [DAB radio \(XAV-AX6050\(EUR\)\)](#)

In-Car Receiver
XAV-AX6000/XAV-AX6050

No FM RDS traffic announcements.

- Disable DAB announcements.
 - FM RDS traffic announcements are not available while DAB announcements are enabled.
-

Related Topic

- [Using DAB Option Functions](#)

In-Car Receiver
XAV-AX6000/XAV-AX6050

There is no picture or picture noise occurs.

- Installation is not correct.
 - Install the unit at an angle of less than 30° in a sturdy part of the car.
- The parking lead (light green) is not connected to the parking brake switch lead, or the parking brake is not applied.
 - Check that the parking lead is firmly connected to the parking brake switch lead, then apply the parking brake.

In-Car Receiver
XAV-AX6000/XAV-AX6050

There is no sound, sound skips, or sound cracks.

- The connection between this unit and the connected equipment has not been established correctly.
 - Check the connection between this unit and the connected equipment and set the input selector of the equipment to the source corresponding to this unit. If the problem continues, disconnect the equipment and reconnect it to this unit.
- Installation is not correct.
 - Install the unit at an angle of less than 30° in a sturdy part of the car.
- The unit is in pause/reverse/fast-forward mode.
- The settings for the outputs are not made correctly.
- The volume is too low or too high.
- The mute function is activated.
- The format is not supported.
 - Check if the format is supported by this unit.
- There may be radio interference in the vicinity.
 - Move to a place with a good signal environment and connect again.

In-Car Receiver
XAV-AX6000/XAV-AX6050

Sound is noisy.

- Keep cords and cables away from each other.

In-Car Receiver
XAV-AX6000/XAV-AX6050

Items cannot be played.

- Reconnect the USB device.
- Make sure the USB device or file is supported.
- USB devices formatted with file systems other than FAT16, FAT32 or exFAT are unsupported.*

* This unit supports FAT16, FAT32 and exFAT, but some USB device may not support all of these. For details, refer to the operating instructions of each USB device or contact the manufacturer.

In-Car Receiver
XAV-AX6000/XAV-AX6050

The USB device takes longer to play.

- The USB device contains large-sized files, large amount of files, or files with a complicated tree structure.

In-Car Receiver
XAV-AX6000/XAV-AX6050

The smartphone connected to the USB port cannot be played.

- The USB connection is only available for Android phones and USB devices in MSC mode.
When using a smartphone other than an Android phone, make a BLUETOOTH connection.
-

Related Topic

- [Pairing and Connecting with a Bluetooth® Device](#)
- [Connecting with a Paired BLUETOOTH Device](#)

In-Car Receiver
XAV-AX6000/XAV-AX6050

The connected HDMI device cannot be played.

- Check the supported file formats for the connected HDMI device.
 - HDMI devices formatted with file systems other than 480p, 576p, or 720p are unsupported.
- If [Video signal not detected] appears on the display, set the resolution of the HDMI device to match the resolution of the unit.
- Check that the HDMI cable is firmly inserted to the unit. It is also recommended to use a certified HDMI cable.
- Disconnect the BLUETOOTH connection, Apple CarPlay, and Android Auto from your iPhone or Android phone that uses an HDMI connection.

In-Car Receiver
XAV-AX6000/XAV-AX6050

The other BLUETOOTH device cannot detect this unit.

- Set [Bluetooth Signal] to [On].
 - Depending on your smartphone or mobile phone, you may need to delete this unit from the history of the connected smartphone or mobile phone, then pair them again.
-

Related Topic

- [Pairing and Connecting with a Bluetooth® Device](#)
- [Connecting with a Paired BLUETOOTH Device](#)
- [Device Connection](#)

In-Car Receiver
XAV-AX6000/XAV-AX6050

Connection is not possible.

- Check the pairing and connection procedures in the manual of the other device, etc., and perform the operation again.

In-Car Receiver
XAV-AX6000/XAV-AX6050

The name of the detected device does not appear.

- Depending on the status of the other device, it may not be possible to obtain the name.

In-Car Receiver
XAV-AX6000/XAV-AX6050

There is no ringtone.

- Raise the volume while receiving a call.
- To adjust the ringtone volume, press HOME, touch [Settings], and select [Ring Tone] of [Volume Settings] in [System].
- The speakers are not connected to the unit.
 - Connect the speakers to the unit. To select the speakers for ringtone, press HOME, then touch [Settings] and select [Optional Audio Output Channel] in [System].

In-Car Receiver
XAV-AX6000/XAV-AX6050

The talker's voice volume is low.

- Raise the volume during a call.
- To adjust the talker's voice volume, press HOME, touch [Settings], and select [Phone Call] of [Volume Settings] in [System].

In-Car Receiver
XAV-AX6000/XAV-AX6050

The other party says that the volume is too low or high.

- Adjust the [MIC Gain] level.
-
-

Related Topic

- [Available Operations during a Call](#)

In-Car Receiver
XAV-AX6000/XAV-AX6050

Echo or noise occurs during call conversations.

- Reduce the volume.
 - If ambient noise other than the phone call sound is loud, try reducing this noise.
 - Shut the window if road noise is loud.
 - Lower the air conditioner if the air conditioner is loud.
-

Related Topic

- [Available Operations during a Call](#)

In-Car Receiver
XAV-AX6000/XAV-AX6050

The phone sound quality is poor.

- Phone sound quality depends on reception conditions of the mobile phone.
 - Move your car to a place where you can enhance the mobile phone's signal if the reception is poor.

In-Car Receiver
XAV-AX6000/XAV-AX6050

The volume of the connected BLUETOOTH device or apps is low or high.

- Volume level will differ depending on the BLUETOOTH device or apps.
 - Reduce the volume level differences between this unit and the BLUETOOTH device or apps.

In-Car Receiver
XAV-AX6000/XAV-AX6050

The sound skips during audio streaming or the BLUETOOTH connection fails.

- Reduce the distance between the unit and the BLUETOOTH device.
- If the BLUETOOTH device is stored in a case which interrupts the signal, remove the case while using the device.
- Several BLUETOOTH devices or other devices (e.g. ham radio devices) which emit radio waves are used nearby.
 - Turn off the other devices.
 - Increase the distance between the unit and other devices.
- Playback sound stops momentarily when this unit is connecting to a mobile phone. This is not a malfunction.

In-Car Receiver
XAV-AX6000/XAV-AX6050

The connected BLUETOOTH device cannot be controlled during audio streaming.

- Check that the connected BLUETOOTH device supports AVRCP.

In-Car Receiver
XAV-AX6000/XAV-AX6050

Some functions do not work.

- Check that the connecting device supports the functions in question.
 - Visit the support site, then check the compatibility list.
-

Related Topic

- [Customer Support Websites](#)

In-Car Receiver
XAV-AX6000/XAV-AX6050

A call is answered unintentionally.

- The connecting phone is set to start a call automatically.
 - [Auto Answer] of this unit is set to [On].
-

Related Topic

- [Available Operations during a Call](#)

In-Car Receiver
XAV-AX6000/XAV-AX6050

Pairing failed due to time out.

- Depending on the connecting device, the time limit for pairing may be short. Try completing the pairing within the time.

In-Car Receiver
XAV-AX6000/XAV-AX6050

Cannot pair.

- The unit may not be able to pair with a previously paired BLUETOOTH device after initializing the unit if the pairing information of the unit is on the BLUETOOTH device. In this case, delete the pairing information of the unit from the BLUETOOTH device, and then pair them again.

In-Car Receiver
XAV-AX6000/XAV-AX6050

The BLUETOOTH function cannot be operated.

- Turn the ignition off. Wait for a while, then turn the ignition to the ACC position.

In-Car Receiver
XAV-AX6000/XAV-AX6050

No sound is output from the car speakers during a handsfree call.

- If the sound is output from the mobile phone, set the mobile phone to output the sound from the car speakers.
- Check the volume level of the car speakers.

In-Car Receiver
XAV-AX6000/XAV-AX6050

A mature channel is not blocked although parental control setting has been made.

- If you tune to a mature channel, the passcode display will appear. Once you have entered the passcode, you will have unblocked parental control for all channels until the unit is powered down or you turn parental control back on. Set [Parental Control] to [Locked] in the SXM option (●●●) again.
-

Related Topic

- [Using SXM Option Functions](#)

In-Car Receiver
XAV-AX6000/XAV-AX6050

The Apple CarPlay icon does not appear on the HOME screen.

- Your iPhone is not compatible with Apple CarPlay.
 - Refer to the manual supplied with your iPhone, or visit the Apple CarPlay website.

- Disconnect your iPhone and reconnect it again.
- Check that the Wi-Fi setting of your iPhone is [ON].
- Check that the GPS antenna (aerial) (supplied) is connected.
- Check that your iPhone is connected with [Device Connection] of [Settings].
- Apple CarPlay may not be available in your country or region.
- Check the setting of Apple CarPlay on your iPhone.
- Remove the HDMI cable from your iPhone.

In-Car Receiver
XAV-AX6000/XAV-AX6050

The position accuracy is not good when using maps with Apple CarPlay.

- Check the location where the GPS antenna (aerial) (supplied) is installed. Some types of front windshields (windcreens) block GPS satellite radio waves. In that case, install the GPS antenna (aerial) (supplied) near the window.
- Do not paint the GPS antenna (aerial) (supplied). It may affect the accuracy.
- The correction status of the internal sensor may be insufficient.
 - Moving your car to a location where no obstacle blocks GPS satellite reception as well as turning left and right several times may improve the performance of the internal sensor.

In-Car Receiver
XAV-AX6000/XAV-AX6050

The Android Auto icon does not appear on the HOME screen.

- Check your Android phone and complete the initial set up process on your Android phone.
- There is no Android Auto application installed on your Android phone.
 - Download and install the Android Auto application or update to the latest version of the application onto your Android phone.
 - The Android Auto app is integrated into phones with Android 10 and above. You do not need to download it. If you need to access the app, you can find it in your phone (Settings/Apps). Android Auto isn't available on devices that run Android (Go edition).
- Your Android phone is not compatible with Android Auto.
 - Your Android phone needs to support Android Auto. Refer to the manual supplied with your Android phone, or visit the Android Auto website.
- Disconnect your Android phone and reconnect it again.
- Check that your Android phone is connected with [Device Connection] of [Settings].
- Android Auto may not be available in your country or region.
- Remove the HDMI cable from your Android phone.

In-Car Receiver
XAV-AX6000/XAV-AX6050

The position accuracy is not good when using maps with Android Auto.

- Check the location where the GPS antenna (aerial) (supplied) is installed. Some types of front windshields (windcreens) block GPS satellite radio waves. In that case, install the GPS antenna (aerial) (supplied) near the window.
- Do not paint the GPS antenna (aerial) (supplied). It may affect the accuracy.
- The correction status of the internal sensor may be insufficient.
 - Moving your car to a location where no obstacle blocks GPS satellite reception as well as turning left and right several times may improve the performance of the internal sensor.

In-Car Receiver
XAV-AX6000/XAV-AX6050

iDataLink Maestro

If you have any inquiries about the functions, settings and connections of iDataLink Maestro, visit the website:

<https://www.idatalinkmaestro.com/>

or contact:

Automotive Data Solutions Inc.

Email: maestrosupport@adsdata.ca

Call: 1-866-427-2999

In-Car Receiver
XAV-AX6000/XAV-AX6050

General

Cannot play selected content

- The currently selected content cannot be played back, or skipped to the next one.
 - The content is not in a supported file format. Check supported file formats.

The device is not responding

- The unit does not recognize the connected USB device.
 - Reconnect the USB device.
 - Check that the USB device is supported by the unit.

No playable content

- The USB device has no playable data.
 - Load the supported data/files into the USB device.

Overcurrent caution on USB

- The USB device is overloaded.
 - Disconnect the USB device.
 - The USB device has a fault, or an unsupported device is connected.

Connected USB device not supported

- For details on the compatibility of your USB device, visit the support site.

USB hub not supported

- USB hubs are not supported on this unit.

Related Topic

- [Customer Support Websites](#)

In-Car Receiver
XAV-AX6000/XAV-AX6050

SiriusXM Connect Vehicle Tuner (XAV-AX6000(UC))

Channel Locked. Please Enter the Lock Code.

- The channel that you have requested is Locked by the radio Parental Control feature. See “[Setting a Parental Control](#)” for more information on the Parental Control feature and how to access locked channels.

Channel Not Available

- The channel that you have requested is not a valid SiriusXM channel or the channel that you were listening to is no longer available.
- You may also see this message briefly when first connecting a new SiriusXM Connect Vehicle Tuner. Visit www.siriusxm.com in the USA or www.siriusxm.ca in Canada for SiriusXM channel lineup information.

Channel Not Subscribed. Call SiriusXM to Subscribe.

- The channel that you have requested is not included in your SiriusXM subscription package or the channel that you were listening to is no longer included in your SiriusXM subscription package. If you have questions about your subscription package or would like to subscribe to this channel, please contact SiriusXM. In the USA, you can activate online or by calling SiriusXM Listener Care:

- Visit www.siriusxm.com/activatenow
- Call SiriusXM Listener Care at 1-866-635-2349

For Canadian Subscriptions, please contact:

- Visit www.siriusxm.ca/activate
- Call SiriusXM Customer Care at 1-888-539-7474

Check Antenna

- The radio has detected a fault with the SiriusXM antenna (aerial).
- The antenna (aerial) cable may be either disconnected or damaged.
 - Verify that the antenna (aerial) cable is connected to the SiriusXM Connect Vehicle Tuner.
 - Inspect the antenna (aerial) cable for damage and kinks.
 - Replace the antenna (aerial) if the cable is damaged. SiriusXM products are available at your local car audio retailer or online at <https://shop.siriusxm.com/all-parts/>

Check SXM Tuner

- The radio is having difficulty communicating with the SiriusXM Connect Vehicle Tuner.
- The tuner may be disconnected or damaged.
 - Verify that the SiriusXM Connect Vehicle Tuner cable is securely connected to the radio.

Incorrect Pass Code entered

- Passcode input failed.
 - Check that the passcode has been entered correctly.
 - If you forget your passcode, perform [SXM Reset] in [Application].
Note that performing [SXM Reset] will initialize all the SiriusXM settings and stored contents in the SiriusXM Connect Vehicle Tuner.

No signal

- SiriusXM Connect Vehicle Tuner is having difficulty receiving the SiriusXM satellite signal.

- Verify that your vehicle is outdoors with a clear view of the sky.
- Verify that the SiriusXM magnetic mount antenna (aerial) is mounted on a metal surface on the outside of the vehicle.
- Move the SiriusXM antenna (aerial) away from any obstructions.
- Inspect the antenna (aerial) cable for damage and kinks.
- Consult the SiriusXM Connect Vehicle Tuner installation manual for more information on antenna (aerial) installation.
- Replace the antenna (aerial) if the cable is damaged. SiriusXM products are available at your local car audio retailer or online at <https://shop.siriusxm.com/all-parts/>

Subscription Updated. Press Enter to Continue.

- The radio has detected a change in your SiriusXM subscription status.
 - Press Enter to clear the message.
If you have questions about your subscription, please contact SiriusXM.
In the USA, you can activate online or by calling SiriusXM Listener Care:
Visit www.siriusxm.com/activatenow
Call SiriusXM Listener Care at 1-866-635-2349
For Canadian Subscriptions, please contact:
Visit www.siriusxm.ca/activate
Call SiriusXM Customer Care at 1-888-539-7474

Related Topic

- [Setting a Parental Control](#)
- [Application](#)

In-Car Receiver
XAV-AX6000/XAV-AX6050

DAB radio (XAV-AX6050(EUR))

No Station

- The DAB signal cannot be received.
 - Update the Station List.
 - Check the connection of the DAB antenna (aerial) (not supplied).
 - Check that [Antenna Power] is set to [On].

Receiving

- The unit is waiting to receive a DAB station.
-

Related Topic

- [Listening to the DAB/DAB+ Radio](#)
- [Using DAB Option Functions](#)

In-Car Receiver
XAV-AX6000/XAV-AX6050

Customer Support Websites

You can access the following customer support websites to get support information about your system.

For customers in the USA/Canada/Latin America:

<https://www.sony.com/am/support>

For customers in European countries:

<https://www.sony.eu/support>

For customers in other countries/regions:

<https://www.sony-asia.com/support>

For customers in the USA

If you have any questions/problems regarding this product, try the following:

1. Read Troubleshooting in this Help Guide.
2. Please contact (U.S.A. only);
Call 1-800-222-7669
URL <https://www.SONY.com>

For customers in European countries

Register your product online now at:

<https://www.sony.eu/mysony>

In-Car Receiver
XAV-AX6000/XAV-AX6050

About the “Support by Sony” App

When you install the “Support by Sony” app on your smartphone, you can get software update information conveniently.

“Support by Sony” app - Find information and get notifications about your product:



- ✓ News & Alerts
- ✓ Software updates
- ✓ Tutorials
- ✓ Tips & Tricks

<https://sony.net/SBS>

Visit the “Support by Sony” website at sony.net/SBS, and bookmark the model name of the unit, “XAV-AX6000” or “XAV-AX6050”, when you visit the website.