

OLED Monitor
SDM-27Q102



Use this Help Guide when you have a question or problem while using this monitor.

Getting Started

[About the manuals for this monitor](#)

Guide to Parts and Controls

[Front view](#)

[Rear view](#)

Setting Up

[Setting up the monitor](#)

[Detaching the stand](#)

[Adjusting the position of the monitor screen](#)

[Carrying the monitor](#)

[Connection example](#)

Using the Monitor

[Turning on/off the power](#)

[Using the joystick](#)

[Switching the input](#)

[Switching the preset mode](#)

[Switching the 24.5 inches mode](#)

Changing the Settings

[Using the menu](#)

[[Picture mode](#)]

[[Gaming assist](#)]

[[Picture adjustment](#)]

[[Input](#)]

[[Volume](#)]

[[Personalize](#)]

[[OSD menu](#)]

[[Panel settings](#)]

[[Others](#)]

Using the useful functions

[Using the USB hub function](#)

[Using INZONE Hub \(Windows\)](#)

Troubleshooting

[Troubleshooting](#)

[Nothing is displayed on the screen, no response to actions](#)

[Horizontal lines appear on the screen](#)

[Flickering on the screen is noticeable](#)

[About screen burn-in](#)

Additional Information

[Support sites](#)

[Supported Formats](#)

Software Update

[Updating the software](#)

Notes on the license

[Notes on the license](#)

5-073-602-11(1) Copyright 2026 Sony Corporation

OLED Monitor
SDM-27Q102

About the manuals for this monitor

The content described in the manuals for this monitor are as follows.

Setup Guide

Explains the setup and connection required to start using this monitor.

Operating Instructions

Explains the safety precautions.

Help Guide (this Web manual)

Explains how to use this monitor.

Note

- The design and specifications of the monitor are subject to change without notice.

Hint

- Letters in brackets [--] displayed on the screen indicate the menu items.
- Details may be omitted from the illustrations.
- The Setup Guide can be downloaded from the support sites.

Related Topic

- [Support sites](#)

OLED Monitor
SDM-27Q102

Front view

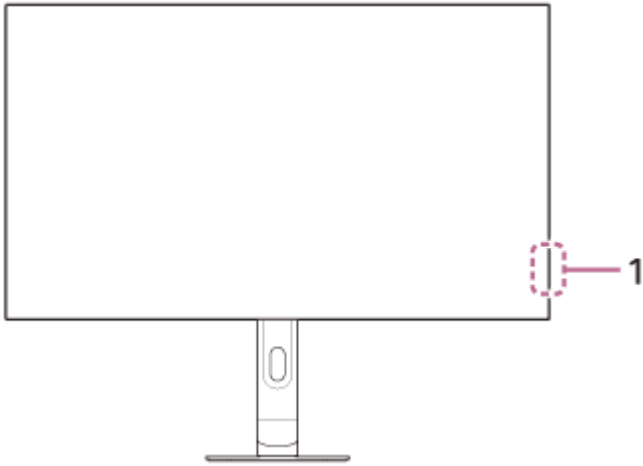

1. Power LED

Indicates the monitor status.

- White: power on
- Amber: on standby
- Off: power off
- Flashing amber: pixel refresh/panel refresh

Rear view

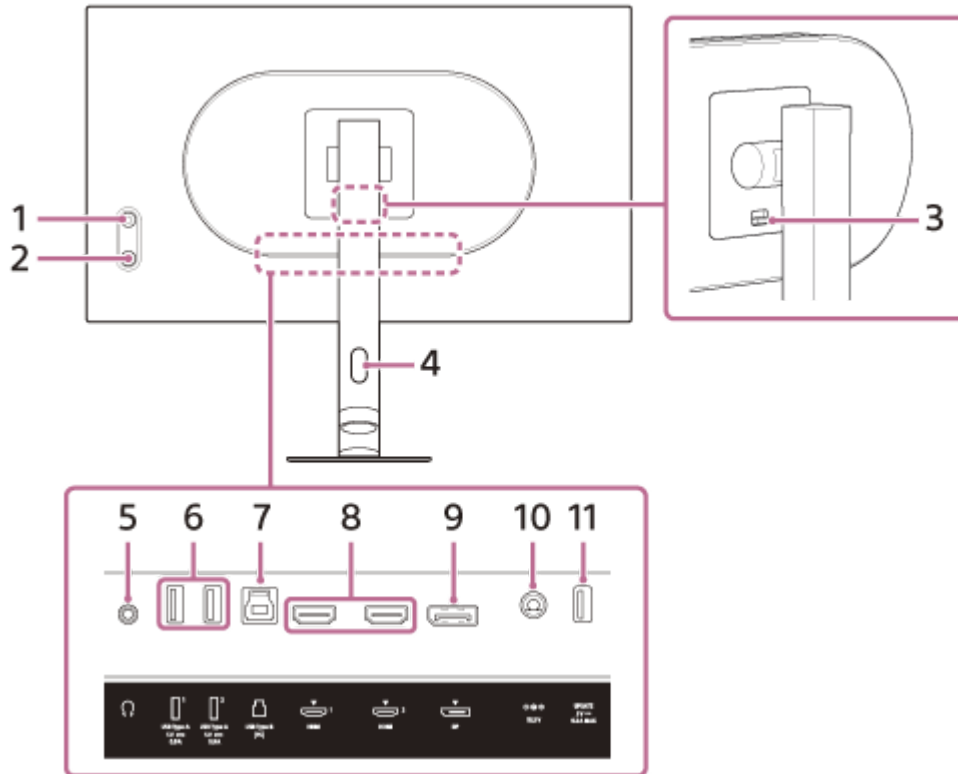

1. Joystick

Used to perform operations such as adjusting the brightness, selecting the input, and displaying the menu to configure settings.

2. Power button

Turns on the power of the monitor. If you press and hold this button while the monitor is on, the monitor is turned off.

3. Stand detach button

Press to detach the stand.

4. Cable through hole

Bundles the cables connected to the monitor by passing them through.

5. Headphones jack

Connect headphones, speaker equipment, etc.

6. USB Type-A port 1, 2

Connect USB peripherals such as a keyboard or mouse.

7. USB Type-B port

When connecting this port to the USB port on a computer, the USB Type-A port of 6. works as the USB hub.

8. HDMI Port 1, 2

Connect to a game console or computer with HDMI output equipped.

9. DisplayPort port

Connect to a computer with the DisplayPort output equipped.

10. DC input terminal

Connect the AC adaptor (supplied).

11. UPDATE port

This is a port for updating the software.

Related Topic

- [\[Personalize\]](#)
- [Using the joystick](#)
- [Detaching the stand](#)

5-073-602-11(1) Copyright 2026 Sony Corporation

OLED Monitor
SDM-27Q102

Setting up the monitor

See the Setup Guide for setup and connection of the monitor.

You can also download it from the support sites below.

- For customers in the USA
<https://www.sony.com/electronics/support>
- For customers in Canada
<https://www.sony.ca/en/electronics/support>
- For customers in Europe
<https://www.sony.eu/support>
- For customers in China
<https://service.sony.com.cn>
- For customers in Asia (or other areas)
<https://www.sony-asia.com/support>

OLED Monitor
SDM-27Q102

Detaching the stand

- 1 Turn off the monitor, maximize the height of the stand, then place it with its OLED panel surface facing down.

Lay a soft cloth on a stable surface so that the OLED panel surface is not damaged.

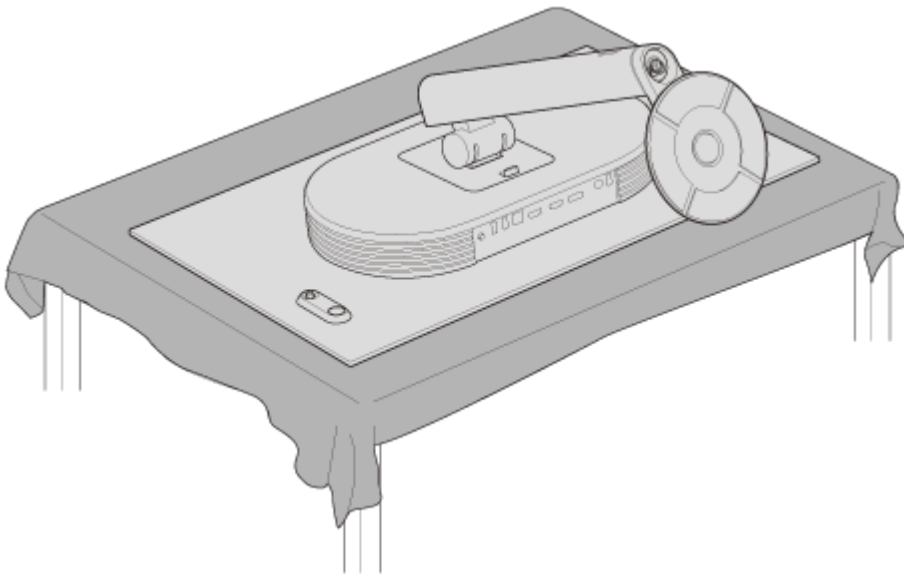

- 2 Detach the pedestal.

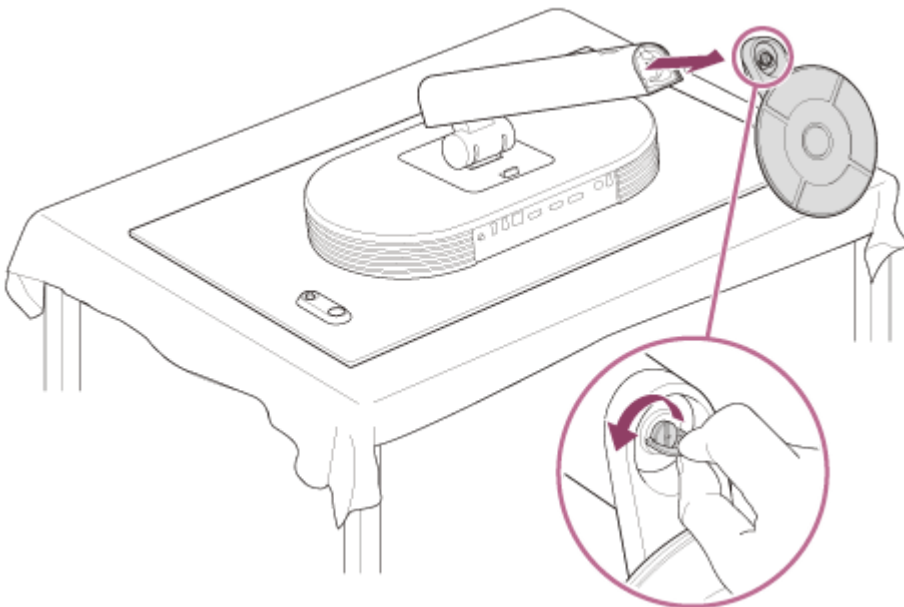

- 3 Press the stand detach button on the rear of the monitor.

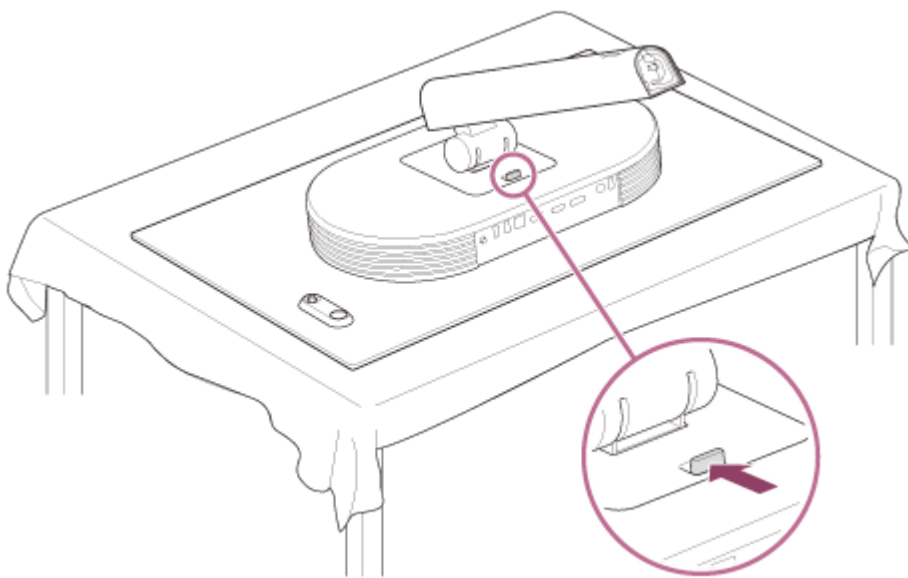

4 Lift up the stand.

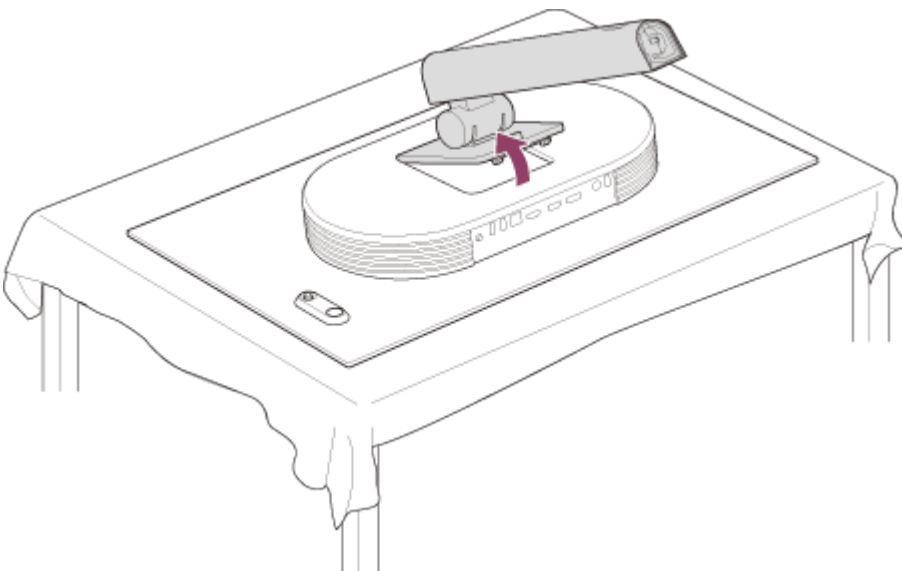

5 Pull out the stand from the monitor.

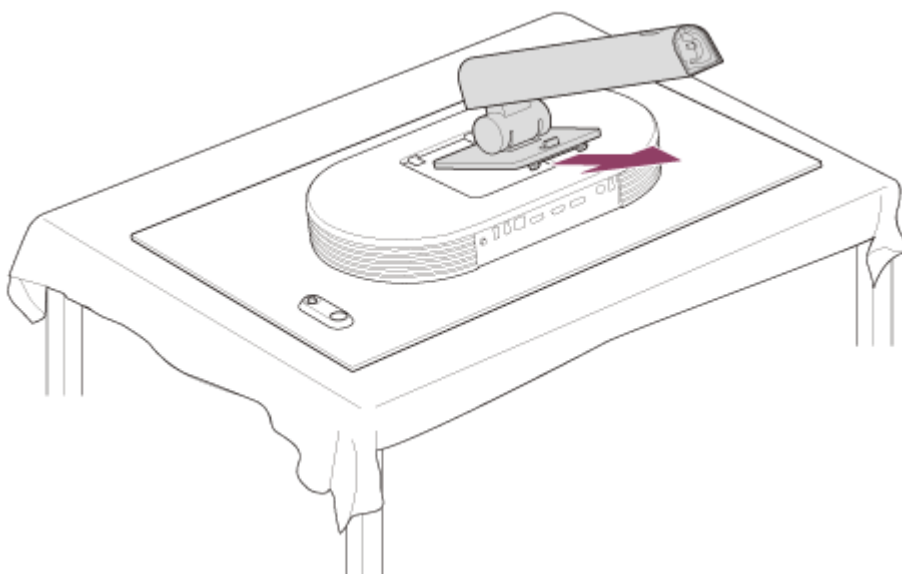

Note

- When detaching the stand, hold the stand tight so as not to touch the OLED panel surface.
- See the Setup Guide for how to attach the detached stand.

Related Topic

- [About the manuals for this monitor](#)
- [Adjusting the position of the monitor screen](#)

5-073-602-11(1) Copyright 2026 Sony Corporation

OLED Monitor
SDM-27Q102

Adjusting the position of the monitor screen

Adjust the height and angle of the monitor to make the screen easier to watch.

To adjust the height

Hold the monitor tight and adjust its height.
Be careful not to touch the OLED panel surface during adjustment.

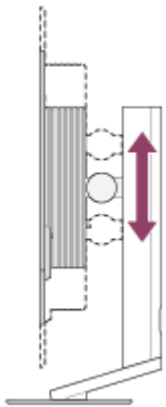

To adjust the angle

Hold the monitor tight and adjust its angle.
Be careful not to touch the OLED panel surface during adjustment.

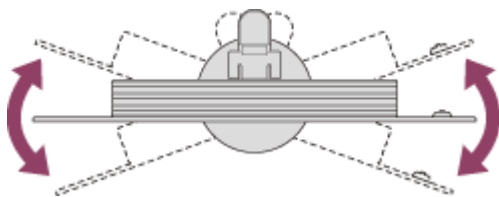
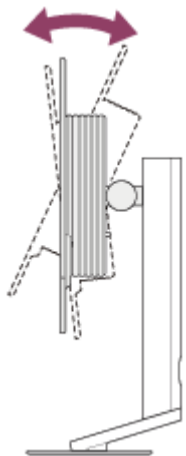

OLED Monitor
SDM-27Q102

Carrying the monitor

When carrying the monitor, with the rear of the monitor facing you, hold the upper part of the stand with one hand and the bottom of the stand with the other hand.

Be careful not touch the OLED panel surface while carrying the monitor.

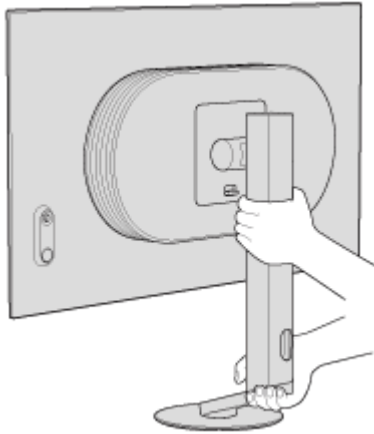

OLED Monitor
SDM-27Q102

Connection example

You can connect devices such as a computer and/or game console to this monitor.

Note

- Be sure to unplug the power cable of the monitor when connecting cords of devices.

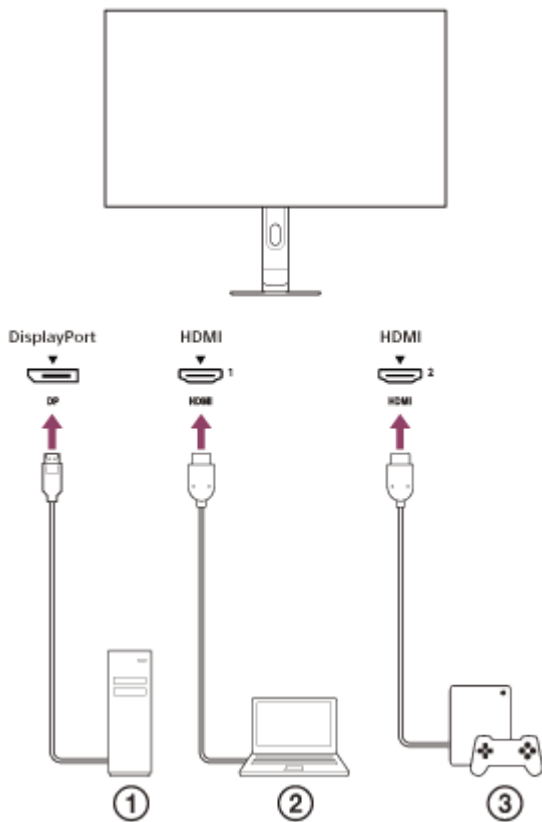

- ① Desktop computer
- ② Laptop computer
- ③ Game console

Note

- When unplugging the DP cable supplied with this monitor, unplug it while pressing the button on the plug.

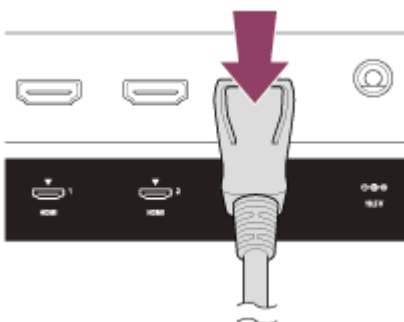

OLED Monitor
SDM-27Q102

Turning on/off the power

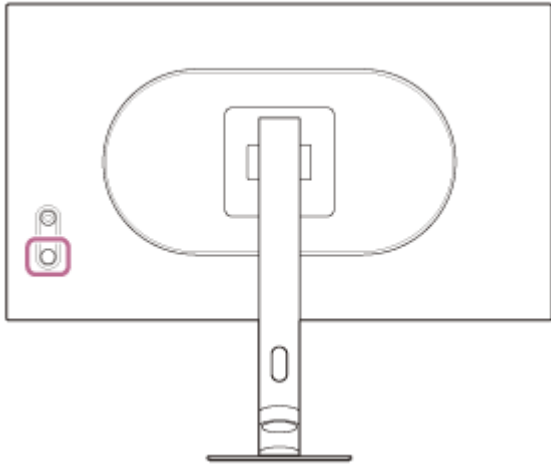

1 Press the power button.

The power indicator lights up in white and the monitor turns on.
Make sure that the connected device is turned on if nothing is displayed on the screen.

2 To turn off, press and hold the power button.

The power indicator goes off and the monitor is turned off.

Hint

- If there is no input signal, the monitor goes into standby mode, and the power indicator lights up in amber.

OLED Monitor
SDM-27Q102

Using the joystick

You can use the joystick to perform operations such as adjusting the brightness, selecting the input, and displaying the menu to configure settings.

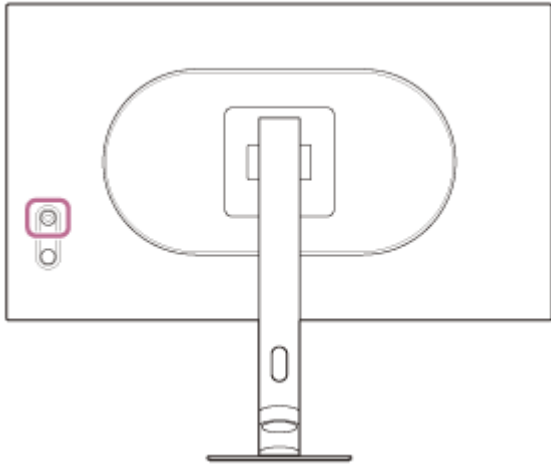

To switch the 24.5 inches mode

While the menu is not displayed, move the joystick on the rear of the monitor down.

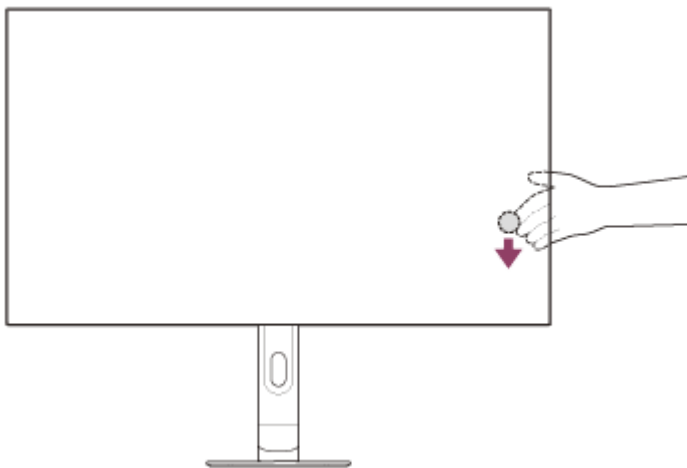

The 24.5 inches mode selection screen is displayed, and you can switch the 24.5 inches mode.

- The 24.5 inches mode selection screen disappears when you move the joystick down while the screen is displayed or no operation is performed for a while.

To adjust the brightness of the screen

While the menu is not displayed, move the joystick on the rear of the monitor up.

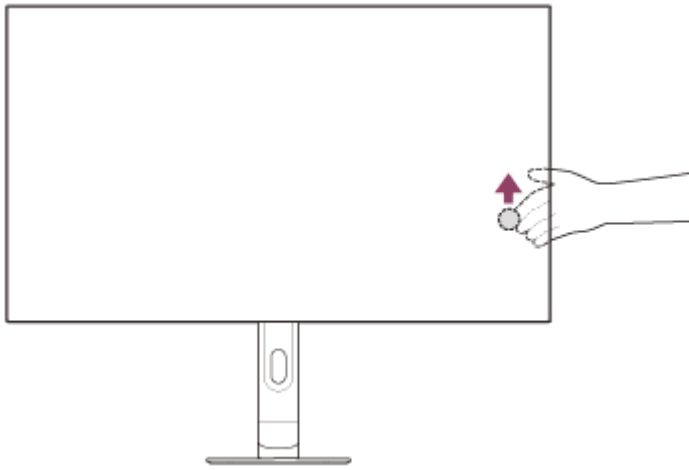

The brightness adjustment screen is displayed, and you can perform the following operations.

- Move it up or to the right to brighten the screen, and move it down or to the left to darken the screen.
- The brightness adjustment screen disappears when you press the joystick while the screen is displayed, or no operation is performed for a while.

To switch the input

While the menu is not displayed, move the joystick on the rear of the monitor to the left when viewed from the front of the monitor.

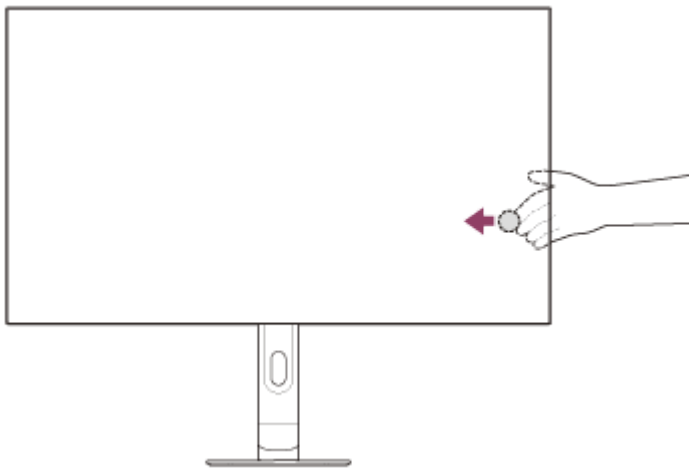

The input selection screen is displayed, and you can select the input.

- The input selection screen disappears when you move the joystick down while the screen is displayed, or no operation is performed for a while.

To switch the preset mode

While the menu is not displayed, move the joystick on the rear of the monitor to the right when viewed from the front of the monitor.

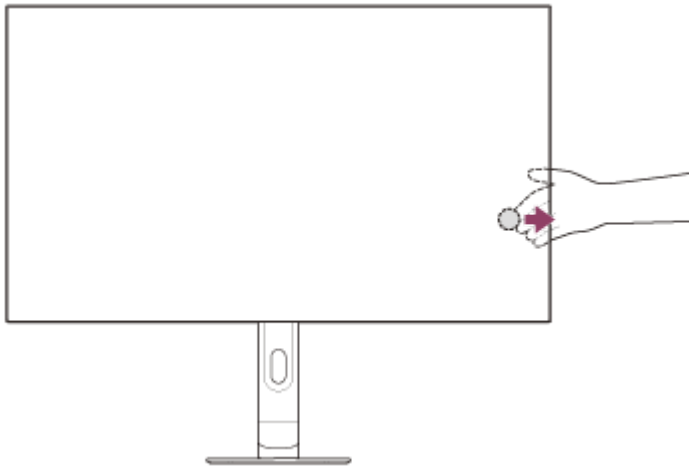

The preset mode selection screen is displayed, and you can select the preset mode.

- The preset mode selection screen disappears when you move the joystick down while the screen is displayed, or no operation is performed for a while.

To display the menu

While the menu is not displayed, press the joystick on the rear of the monitor.



The menu is displayed, and you can perform input selection and various settings by moving the joystick up, down, to the left, and to the right.

To turn off the menu

Move the joystick repeatedly to the left.

Related Topic

- [Switching the 24.5 inches mode](#)
- [\[Picture adjustment\]](#)
- [Switching the input](#)
- [Switching the preset mode](#)
- [Using the menu](#)
- [\[Others\]](#)

OLED Monitor
SDM-27Q102

Switching the input

This monitor automatically selects the input with a signal input.

If there are multiple input signals, the inputs are selected in the following order of priority.

HDMI 1→HDMI 2→DisplayPort

To switch the input manually, use the joystick.

1 Move the joystick to the left.

The input selection menu is displayed.

2 Select the desired input.

3 Press the joystick.

The input switches to the one selected.

Note

- When [Auto input switch] is set to [Off], the input is not selected automatically.
- When [Control for HDMI] is set to [On], the input of that device is automatically selected when turned on or operated.
- If there is no input signal, the input is not selected.

Related Topic

- [\[Input\]](#)

Switching the preset mode

You can select the desired image quality from the presets.

1 Move the joystick to the right.

The preset selection menu is displayed.

2 Select the desired image quality.

Picture quality settings are previewed.

3 Press the joystick.

The image quality switches to the one selected.

Related Topic

- [\[Picture mode\]](#)

OLED Monitor
SDM-27Q102

Switching the 24.5 inches mode

You can select the settings of the 24.5 inches mode.

1 Move the joystick down.

The 24.5 inches mode selection menu is displayed.

2 Select the desired setting.

3 Press the joystick.

The setting switches to the one selected.

OLED Monitor
SDM-27Q102

Using the menu

You can make various settings for this monitor on the menu setting screen.

1 Press the joystick on the rear of the monitor.

The menu setting screen is displayed.

2 Select the desired setting with the joystick, select the setting value, then press it.

To turn off the menu setting screen

The menu setting screen will turn off automatically if no operation is performed for a while.
Also, move the joystick repeatedly to the left to turn off the setting menu screen.

OLED Monitor
SDM-27Q102

[Picture mode]

You can select the desired image quality from the presets and adjust the image quality automatically.

- 1 Press the joystick on the rear of the monitor and move it up, down, to the left, or to the right to display the setting screen.
- 2 Select the desired setting and press the joystick.

Details of the menu items

[Preset mode]

Select the desired setting from the presets.

SDR and HDR are exchanged according to the input signal format.

When the input signal is SDR

[FPS Pro+]: Suitable for playing FPS (first person shooter) games. Makes the outline of the target stand out.

[FPS Pro]: Suitable for playing FPS (first person shooter) games. This mode simulates the image quality on an LCD e-sports monitor.

[MOBA/RTS]: Suitable for playing MOBA/RTS (Multiplayer Online Battle Arena/Real-time Strategy) games.

[Cinema]: Suitable for watching movies and videos.

[Game]: You can enjoy various game genres.

[Custom]: You can customize picture quality settings.

[Standard]: Standard image quality mode.

[sRGB]: An image quality mode based on the sRGB standard.

When the input signal is HDR

[Standard]: Standard picture quality mode.

[Cinema]: Suitable for watching movies and videos.

[Game]: You can enjoy various game genres.

[Custom]: You can customize picture quality settings.

[RPG]: Suitable for playing RPG (Role Playing Game) games.

[Auto picture mode]

When an HDMI device is connected, the picture quality is automatically selected to match the content to be played back.

[Off]: Turns off this function.

[On]: Turns on the [Auto picture mode].

Note

- When [Auto picture mode] is set to [On], the image quality mode selected in [Auto picture mode] is applied regardless of the [Preset mode] setting.
- When the input signal is HDR, some functions cannot be set.

Hint

- HDR stands for High Dynamic Range. It is a technology that expresses the wide range of brightnesses from the light part to the dark part in a way superior to SDR (Standard Dynamic Range). Blown-out highlights and the blocked-up shadows may occur in the general SDR image. However, the HDR images realize a natural and real gradation of light and dark more superior compared to SDR.

Related Topic

- [\[Picture adjustment\]](#)

5-073-602-11(1) Copyright 2026 Sony Corporation

OLED Monitor
SDM-27Q102

[Gaming assist]

You can make settings for useful functions during the game.

- 1 Press the joystick on the rear of the monitor and move it up, down, to the left, or to the right to display the setting screen.
- 2 Select the desired setting and press the joystick.

Details of the menu items

[Max frame rate]

You can change the maximum frequency.

[480 Hz]: The maximum frequency is set to 480 Hz.

[540 Hz]: The maximum frequency is set to 540 Hz.

[720 Hz (HD)]: The maximum frequency is set to 720 Hz. The resolution is limited to a maximum of 1280×720.

[Black equalizer]

Improve visibility in dark areas of the screen.

[0] to [10]: The larger the value, the better the visibility of dark areas.

[24.5-inch mode]

Switch the screen size to a size equivalent to 24.5 inches.

[Off]: Generally, use in this mode.

[Center]: Turns on the 24.5 inches mode in the center of the screen.

[Bottom]: Turns on the 24.5 inches mode at the bottom of the screen.

[24.5-inch resolution (PC)]

Toggle the maximum resolution in 24.5 inches mode when connected to a PC.

[2368x1332 (pixel-by-pixel)]: Displays the resolution with pixel-by-pixel up to 2368×1332.

[1920x1080]: Displays the resolution at a maximum of 1920×1080.

[Motion blur reduction]

Reduces motion blur in video.

[Off]: Turns off motion blur reduction.

[On]: Turns on motion blur reduction.

[Adaptive-Sync/VRR]

Synchronize the refresh rate of this monitor with the frame rate of the video. When turned on, you can suppress stuttering (lagging) and tearing (misalignment) of the screen during the game.

[Off]: Turns off this function.

[On]: Turns on the Adaptive-Sync/VRR function.

[Anti-VRR flicker]

Suppresses flickering of the screen during VRR operation.

[Off]: Turns off Anti-VRR flicker.

[Mid]: Moderately suppresses VRR flicker.

[High]: Highly suppresses VRR flickering.

[Extreme]: Completely suppresses VRR flickering.

[Frame rate counter]

Display the frame rate per second of the input signal in real time.

[Off]: Does not display the frame rate.

[On]: Displays the frame rate.

[Low latency]

Control the amount of latency in the video input.

[Off]: Turns off the function that controls the latency in the video input.

[On]: Controls the amount of latency in the video input.

[Crosshair]

Turn on the crosshairs (cross mark) in the center of the screen.

[Off]: Turns off the crosshairs.

[Cursor 1] to [Cursor 8]: Select the desired shape to display from the 8 types. [Cursor 5] - [Cursor 8] automatically changes the color of the cursor to match the background color.

[Timer]

Set a timer to indicate the remaining time.

[Off]: Turns off the timer.

[10:00] to [60:00]: Turns on the timer with the time set.

[Reset]

Resets the current input and settings of [Gaming assist] set in [Preset mode].

Note

- With HDMI input and DP1.2 input, [Max frame rate] and [Anti-VRR flicker] cannot be selected.
- This monitor supports dual mode (QHD 540 Hz/HD 720 Hz).
For QHD 540 Hz, select [Gaming assist] → [Max frame rate] → [540 Hz] in the menu.
For HD 720 Hz, select [Gaming assist] → [Max frame rate] → [720 Hz (HD)] in the menu.
- If you select [720 Hz (HD)] in [Max frame rate], the OSD menu display will be enlarged vertically because of a special mode that displays two lines simultaneously.
- If you select [720 Hz (HD)] in [Max frame rate], [Motion blur reduction], [Aspect ratio], [Text Magnification], etc. cannot be set.
- When switching the 24.5 inches mode, the display may shift according to the game. In this case, restart the game application.
- When [24.5-inch mode] is activated, [Aspect ratio] and [Power saving] cannot be adjusted.
- When [Motion blur reduction] is selected, [Adaptive-Sync/VRR] is not available.
- If you select [High] or [Mid] in [Anti-VRR flicker], the refresh rate variable range is reduced.
- When [Adaptive-Sync/VRR] is set to on, [Original] in [Aspect ratio] cannot be selected.
- In any of the following setting conditions, the video delay may increase (up to about 1 frame).
[Motion blur reduction]: [On]
[Adaptive-Sync/VRR]: [Off]
[Anti-VRR flicker]: [Extreme]
[Low latency]: [Off]

OLED Monitor
SDM-27Q102

[Picture adjustment]

You can adjust the image quality such as brightness and contrast.

- 1 Press the joystick on the rear of the monitor and move it up, down, to the left, or to the right to display the setting screen.
- 2 Select the desired setting and press the joystick.

Details of the menu items

[Brightness]

Adjust the brightness of the screen.

[0] to [100]: The higher the value, the brighter the screen.

[Brightness stabilizer]

Maintain the screen brightness at a certain level of brightness.

[Off]: Turns off this function. Generally, use in this mode.

[Mid], [High]: Select the level to which the effect is applied.

[Contrast]

Adjust the contrast of the screen.

[0] to [100]: The higher the value, the larger the difference between the lighter and darker parts of the screen.

[Sharpness]

Adjust the sharpness of the screen.

[0] to [100]: The higher the value, the clearer the screen, and the lower the value, the softer the screen.

[Gamma]

Select the gamma value from [1.8], [2.0], [2.2], [2.4], [2.6] and [S-curve], and set it to be the optimum condition according to the image.

The lower the gamma value, the brighter the intermediate colors (other than white and black).

[Hue]

Adjust the hue of the screen.

[0] to [100]: The higher the value, the more greenish the color, and the lower the value, the more purplish the color.

[Saturation]

[Standard]

Adjust the density of all colors of the screen.

[0] to [100]: The higher the value, the deeper the color, and the lower the value, the lighter the color.

[Advanced]

[0] to [40]: The higher the value, the deeper the color, and the lower the value, the lighter the color.

[Red]: Adjusts the density of red.

[Green]: Adjusts the density of green.

[Blue]: Adjusts the density of blue.

[Cyan]: Adjusts the density of cyan.

[Magenta]: Adjusts the density of magenta.

[Yellow]: Adjusts the density of yellow.

[Color temperature]

Adjust the color temperature of the screen.

[Cool]: Raises the color temperature (to be bluish) of the screen.

[Neutral]: Sets to standard color temperature.

[Warm]: Lowers the color temperature (to be reddish) of the screen.

[Custom]: Adjusts the red, green, and blue values to set the desired color temperature.

[0] to [100]: The higher the value, the higher the color temperature, and the lower the value, the lower the color temperature.

- [Red]: Adjusts the red value.
- [Green]: Adjusts the green value.
- [Blue]: Adjusts the blue value.

[Aspect ratio]

Set the aspect ratio of the screen.

[Auto resize]: Adjusts the aspect ratio according to the video signal.

[16:9]: Sets the aspect ratio to 16:9.

[Original]: Displays images with the original aspect ratio maintained.

[Reset]

Resets the current input and settings of [Picture adjustment] set in [Preset mode].

Hint

- You can also adjust the brightness of the screen by moving the joystick up and then up or down while the menu is not displayed.

Note

- You may not be able to adjust [Gamma] according to the preset mode.
- When [Power saving] is on, [Brightness] is limited.

OLED Monitor
SDM-27Q102

[Input]

You can select the input and make settings related to the input.

- 1 Press the joystick on the rear of the monitor and move it up, down, to the left, or to the right to display the setting screen.
- 2 Select the desired setting and press the joystick.

Details of the menu items

[HDMI 1]

Selects the HDMI 1 input.

[HDMI 2]

Selects the HDMI 2 input.

[DP]

Selects the DisplayPort input.

[Auto input switch]

Select the input with the input signal automatically.

If there are multiple input signals, the inputs are selected in the following order of priority.

HDMI 1→HDMI 2→DisplayPort

[Off]: Turns off this function.

[On]: Turns on the auto input select function.

[Control for HDMI]

In conjunction with the monitor, you can perform operations, such as turning on/off or selecting the input, of the device connected with an HDMI cable.

[Off]: Turns off this function.

[On]: Turns on the HDMI device control function.

[DP version number]

Set the DisplayPort version number.

Set to the same version as the DisplayPort of the connected device.

[1.2]/[1.4]/[2.1]

Note

- To display DisplayPort version 2.1 compliant images, DisplayPort version 2.1 compliant cables and connected devices are required. The supplied DisplayPort cable supports the version 2.1.

Hint

- If the connected device does not support the DisplayPort version, the screen may be displayed improperly. In this case, the screen will be displayed properly by changing the DisplayPort version from high to low ([2.1] → [1.4] → [1.2]).

OLED Monitor
SDM-27Q102

[Volume]

You can adjust the volume on the headphones or speaker equipment.

- 1 Press the joystick on the rear of the monitor and move it up, down, to the left, or to the right to display the setting screen.
- 2 Select the desired setting and press the joystick.

Details of the menu items

[Volume]

[0] to [100]: The higher the value, the louder the volume.

Note

- The speaker of this monitor only outputs the audio of the [Screen reader].

OLED Monitor
SDM-27Q102

[Personalize]

You can make the settings of the power LED.

- 1** Press the joystick on the rear of the monitor and move it up, down, to the left, or to the right to display the setting screen.
- 2** Select the desired setting and press the joystick.

Details of the menu items

[Power LED]

You can turn off the power LED even though the monitor is turned on.

[On]: Turns on the power LED.

[Off]: Turns off the power LED.

OLED Monitor
SDM-27Q102

[OSD menu]

You can set the language and other details of the menu setting screen.

- 1** Press the joystick on the rear of the monitor and move it up, down, to the left, or to the right to display the setting screen.
- 2** Select the desired setting and press the joystick.

Details of the menu items

[Language]

Set the language of the menu setting screen.

[Transparency]

Set the transparency of the menu setting screen.

[0] to [100]: The higher the value, the greater the transparency.

[OSD time out]

Set the time for displaying the menu setting screen.

[5s] to [60s]: Set between 5 seconds to 60 seconds. After the set time has elapsed, the menu setting screen closes.

OLED Monitor
SDM-27Q102

[Panel settings]

You can make settings for the screen protection and screen correction.

- 1 Press the joystick on the rear of the monitor and move it up, down, to the left, or to the right to display the setting screen.
- 2 Select the desired setting and press the joystick.

Details of the menu items

[Screen saver]

Protect the screen by lowering the screen brightness after a certain period of computer, game console, or monitor inactivity.

[Off]: Turns off this function.

[On]: Turns on the screen saver function.

[Pixel shift]

Protect the screen by gradually changing the position in which the image is displayed while the monitor is being used.

[Off]: Turns off this function.

[Low], [Mid], [High]: Select the level to which the effect is applied.

[Pixel refresh]

Adjusts each pixel to reduce uneven wear on the screen when the monitor is being used for an extended period of time.

[Panel refresh]

Adjusts the entire screen to reduce uneven wear on the screen when the monitor is being used for an extended period of time.

Note

- Avoid performing a panel refresh 2 or more times a year, as this can damage the panel.
- A pixel refresh takes about 5 minutes. A panel refresh takes about 1 minute.
- The effectiveness of the pixel refresh function or panel refresh function varies depending on the amount of burn-in on the screen.
- In addition to the menu operations described above, pixel refresh or panel refresh is performed automatically when the monitor is turned off or enters standby mode.
- Do not touch the monitor during pixel refresh.

OLED Monitor
SDM-27Q102

[Others]

You can make settings related to this monitor and initialize this monitor.

- 1 Press the joystick on the rear of the monitor and move it up, down, to the left, or to the right to display the setting screen.
- 2 Select the desired setting and press the joystick.

Details of the menu items

[DDC/CI]

Make settings on this monitor using the dedicated software on the computer.

[Off]: Turns off this function.

[On]: Turns on the DDC/CI function.

[Power saving]

Reduce the screen brightness to lower the power consumption.

[Off]: Turns off this function. Consumes power normally.

[On]: Turns on the Power saving function.

[Text magnification]

The letters on the menu setting screen are displayed in large sizes.

[Off]: Turns off this function.

[On]: Turns on the Text magnification function.

[Text magnification] works only when [Language] is set to [English].

[Screen reader]

You can operate the monitor by voice without watching the screen.

[Off]: Turns off this function.

[On]: Turns on the Screen reader function.

[Screen reader] works only when [Language] is set to [English].

[Software version]

The software version of this monitor can be viewed.

[USB software update]

Updates the software by using a USB memory.

[Factory reset]

Resets the settings of the monitor to the factory default.

Note that all the settings of the monitor return to the factory default.

Note

- When [Power saving] is set to on, [Text magnification] and [Screen reader] cannot be set.
- When [Power saving] is set to on, some functions of [Gaming assist] and [Picture adjustment] cannot be adjusted.
- When [Power saving] is set to on, [DP version number] cannot be set.
- When [Power saving] is on, the maximum input refresh rate is limited.

- When [Power saving] is set to on, HDR images cannot be displayed with the DP input. Select the HDMI input or set [Power saving] to off to display HDR images.

Related Topic

- [Updating the software](#)

5-073-602-11(1) Copyright 2026 Sony Corporation

OLED Monitor
SDM-27Q102

Using the USB hub function

When a computer is connected to the monitor, you can use the USB device (such as a keyboard and mouse) connected to the monitor to control the computer.

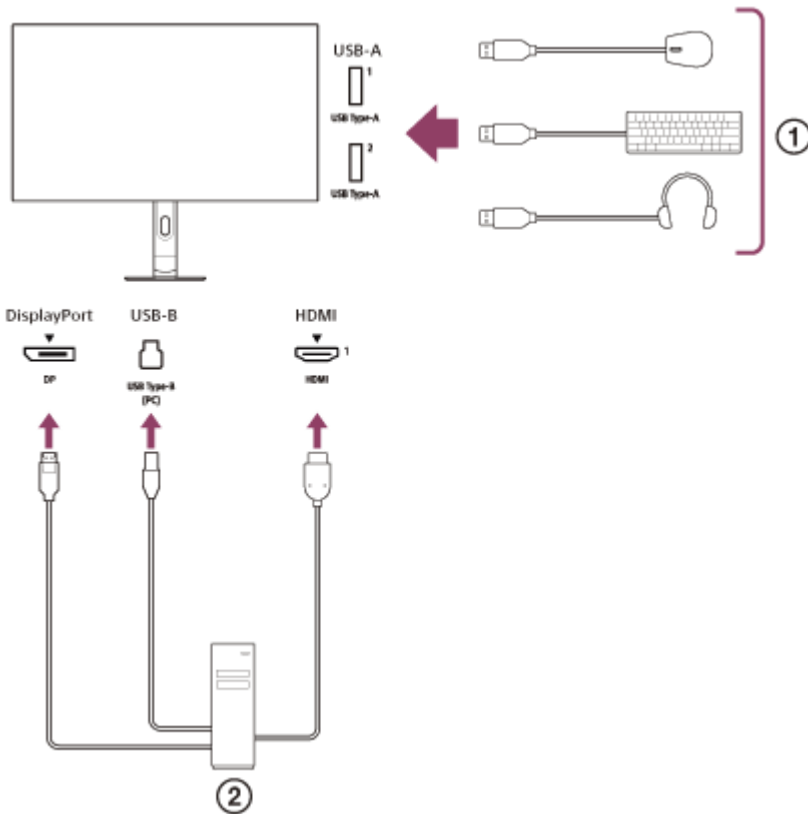

- ① Mouse, keyboard, headset, etc.
- ② Computer

OLED Monitor
SDM-27Q102

Using INZONE Hub (Windows)

By using the software, you can make various settings for this monitor from your computer.
The software can be downloaded from the support sites below.

- For customers in the USA
<https://www.sony.com/electronics/support>
- For customers in Canada
<https://www.sony.ca/en/electronics/support>
- For customers in Europe
<https://www.sony.eu/support>
- For customers in China
<https://service.sony.com.cn>
- For customers in Asia (or other areas)
<https://www.sony-asia.com/support>

OLED Monitor
SDM-27Q102

Troubleshooting

If the monitor is not working properly, check again for problems before sending it for repair.
Should any problems persist, consult your nearest Sony dealer.

5-073-602-11(1) Copyright 2026 Sony Corporation

OLED Monitor
SDM-27Q102

Nothing is displayed on the screen, no response to actions

Try the following.

- If the equipment connected to the monitor is not powered on, turn it on.
 - Check that the power cord or the connection cables to other equipment are properly connected.
 - Turn off the power by pressing the power button on the back of the monitor. Then, wait a few seconds and press the power button again to turn it back on.
 - Disconnect the power cord of the monitor from the outlet, wait about 10 seconds, and then connect the power cord to the outlet.
 - Try updating the monitor software. Refer to the [“Updating the software”](#) section of this help guide.
-

Related Topic

- [Connection example](#)
- [Setting up the monitor](#)
- [Turning on/off the power](#)
- [Updating the software](#)

OLED Monitor
SDM-27Q102

Horizontal lines appear on the screen

Try the pixel refresh from the menu below.

[Panel settings] - [Pixel refresh] - [OK]

Related Topic

- [\[Panel settings\]](#)

OLED Monitor
SDM-27Q102

Flickering on the screen is noticeable

Try Anti-VRR flicker from the menu below.

[Gaming assist] - [Anti-VRR flicker] - [Mid] [High] [Extreme]

Related Topic

- [\[Gaming assist\]](#)

OLED Monitor
SDM-27Q102

About screen burn-in

This monitor has technical measures to suppress burn-in on the OLED panel. If it is displayed that pixel refresh or panel refresh is to be performed, it is recommended to perform as instructed.

Also, do not disconnect the power cord even when you are not using the monitor, as the monitor automatically performs pixel refresh and panel refresh when it is on standby or turned off with the power button.

OLED Monitor
SDM-27Q102

Support sites

Visit the support sites below for the latest information.

- For customers in the USA
<https://www.sony.com/electronics/support>
- For customers in Canada
<https://www.sony.ca/en/electronics/support>
- For customers in Europe
<https://www.sony.eu/support>
- For customers in China
<https://service.sony.com.cn>
- For customers in Asia (or other areas)
<https://www.sony-asia.com/support>

Supported Formats

Each input supports the formats marked with " ○ ".

PC formats

Resolution	Vertical frequency (Hz)	HDMI	DP
640×480	60	○	○
800×600	60	○	○
960×720	480	–	○
960×720	720	–	○
1024×768	60	○	○
1280×720	60	–	○
1280×720	480	–	○
1280×720	720	–	○
1280×1024	60	○	○
1920×1080	60	○	○
1920×1080	120	○	○
1920×1080	240	–	○
1920×1080	270	–	○
1920×1080	360	–	○
1920×1080	480	–	○
1920×1080	540	–	○
2560×1440	60	○	○
2560×1440	120	○	○
2560×1440	240	○	○
2560×1440	270	–	○
2560×1440	360	○	○
2560×1440	480	○	○
2560×1440	540	–	○
2368×1332	60	○	○

Resolution	Vertical frequency (Hz)	HDMI	DP
2368×1332	120	○	○
2368×1332	240	○	○
2368×1332	270	–	○
2368×1332	360	○	○
2368×1332	480	○	○
2368×1332	540	–	○

CE formats

Resolution	Vertical frequency (Hz)	HDMI	DP
640×480	60	○	○
720×480	59.94	○	○
720×480	60	○	○
720×576	50	○	○
1280×720	50	○	○
1280×720	60	○	○
1920×1080	24	○	○
1920×1080	25	○	○
1920×1080	30	○	○
1920×1080	50	○	○
1920×1080	60	○	○
1920×1080	120	○	○
1920×1080	240	–	○
1920×1080	360	–	○
1920×1080	480	–	○
1920×1080	540	–	○

Updating the software

You can update the software of the monitor.

1 Download the update file.

Download the update file to your computer from the support sites.

2 Expand the update file.

1: Expanding the update file

Since the downloaded update file is compressed, right click on the file, and select the item for expanding the file. Then, the file will be expanded.

You may not be able to expand the file with the above procedure depending on your OS environment.

2: Confirming the expanded file

Confirm that the name of the expanded file is "SDM-27Q102.bin".

Do not change the file name.

3 Copy the file to a USB memory.

1: Preparing a USB memory

Prepare the USB memory with a FAT32 or NTFS file system.

2: Copying the file to your USB memory

Copy the expanded file to the root directory (top layer) of the USB memory.

4 Insert the USB memory into the monitor.

1: Pulling the USB memory out of your computer

Follow the procedure of your OS to pull the USB memory out of your computer.

2: Inserting the USB memory into the monitor

Insert the USB memory into the UPDATE port of the monitor.

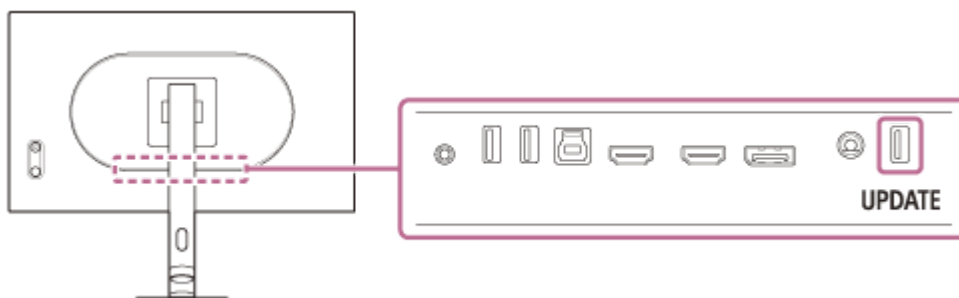

5 Update the monitor.

Select [Others] and then [USB software update] in the menu.

The progress is displayed on the screen during the update. Then, the monitor restarts automatically after the update is finished. The update requires about 1 minute.

- When you put the update file on a layer other than the root directory of the USB memory or change the name of the update file, you cannot update the monitor.
- You can update the monitor via the UPDATE port only.
- Do not pull out the power cable, USB memory and connection cable during the update.
- Some USB memories are not supported.

5-073-602-11(1) Copyright 2026 Sony Corporation

OLED Monitor
SDM-27Q102

Notes on the license

This monitor uses the software for which we have a license agreement with the copyright owner. According to the request of the software copyright owner, we have a duty to inform the contents of the license to customers.

The license is described below.

Zlib

(C) 1995 Jean-loup Gailly and Mark Adler

This software is provided 'as-is', without any express or implied warranty. In no event will the authors be held liable for any damages arising from the use of this software.

Permission is granted to anyone to use this software for any purpose, including commercial applications, and to alter it and redistribute it freely, subject to the following restrictions:

1. The origin of this software must not be misrepresented; you must not claim that you wrote the original software. If you use this software in a product, an acknowledgment in the product documentation would be appreciated but is not required.
2. Altered source versions must be plainly marked as such, and must not be misrepresented as being the original software.
3. This notice may not be removed or altered from any source distribution.

Jean-loup Gailly Mark Adler
gzip@prep.ai.mit.edu madler@alumni.caltech.edu

If you use the zlib library in a product, we would appreciate *not* receiving lengthy legal documents to sign. The sources are provided for free but without warranty of any kind. The library has been entirely written by Jean-loup Gailly and Mark Adler; it does not include third-party code.

If you redistribute modified sources, we would appreciate that you include in the file ChangeLog history information documenting your changes.

MbedTLS

Apache License
Version 2.0, January 2004
<http://www.apache.org/licenses/>

TERMS AND CONDITIONS FOR USE, REPRODUCTION, AND DISTRIBUTION

1. Definitions.

"License" shall mean the terms and conditions for use, reproduction, and distribution as defined by Sections 1 through 9 of this document.

"Licensor" shall mean the copyright owner or entity authorized by the copyright owner that is granting the License.

"Legal Entity" shall mean the union of the acting entity and all other entities that control, are controlled by, or are under common control with that entity. For the purposes of this definition, "control" means (i) the power, direct or indirect, to cause the direction or management of such entity, whether by contract or otherwise, or (ii) ownership of fifty percent (50%) or more of the outstanding shares, or (iii) beneficial ownership of such entity.

"You" (or "Your") shall mean an individual or Legal Entity exercising permissions granted by this License.

"Source" form shall mean the preferred form for making modifications, including but not limited to software source code, documentation source, and configuration files.

"Object" form shall mean any form resulting from mechanical transformation or translation of a Source form, including but not limited to compiled object code, generated documentation, and conversions to other media types.

"Work" shall mean the work of authorship, whether in Source or Object form, made available under the License, as indicated by a copyright notice that is included in or attached to the work (an example is provided in the Appendix below).

"Derivative Works" shall mean any work, whether in Source or Object form, that is based on (or derived from) the Work and for which the editorial revisions, annotations, elaborations, or other modifications represent, as a whole, an original work of authorship. For the purposes of this License, Derivative Works shall not include works that remain separable from, or merely link (or bind by name) to the interfaces of, the Work and Derivative Works thereof.

"Contribution" shall mean any work of authorship, including the original version of the Work and any modifications or additions to that Work or Derivative Works thereof, that is intentionally submitted to Licensor for inclusion in the Work by the copyright owner or by an individual or Legal Entity authorized to submit on behalf of the copyright owner. For the purposes of this definition, "submitted" means any form of electronic, verbal, or written communication sent to the Licensor or its representatives, including but not limited to communication on electronic mailing lists, source code control systems, and issue tracking systems that are managed by, or on behalf of, the Licensor for the purpose of discussing and improving the Work, but excluding communication that is conspicuously marked or otherwise designated in writing by the copyright owner as "Not a Contribution."

"Contributor" shall mean Licensor and any individual or Legal Entity on behalf of whom a Contribution has been received by Licensor and subsequently incorporated within the Work.

2. Grant of Copyright License. Subject to the terms and conditions of this License, each Contributor hereby grants to You a perpetual, worldwide, non-exclusive, no-charge, royalty-free, irrevocable copyright license to reproduce, prepare Derivative Works of, publicly display, publicly perform, sublicense, and distribute the Work and such Derivative Works in Source or Object form.

3. Grant of Patent License. Subject to the terms and conditions of this License, each Contributor hereby grants to You a perpetual, worldwide, non-exclusive, no-charge, royalty-free, irrevocable (except as stated in this section) patent license to make, have made, use, offer to sell, sell, import, and otherwise transfer the Work, where such license applies only to those patent claims licensable by such Contributor that are necessarily infringed by their Contribution(s) alone or by combination of their Contribution(s) with the Work to which such Contribution(s) was submitted. If You institute patent litigation against any entity (including a cross-claim or counterclaim in a lawsuit) alleging that the Work or a Contribution incorporated within the Work constitutes direct or contributory patent infringement, then any patent licenses granted to You under this License for that Work shall terminate as of the date such litigation is filed.

4. Redistribution. You may reproduce and distribute copies of the Work or Derivative Works thereof in any medium, with or without modifications, and in Source or Object form, provided that You meet the following conditions:

(a) You must give any other recipients of the Work or Derivative Works a copy of this License; and

(b) You must cause any modified files to carry prominent notices stating that You changed the files; and

(c) You must retain, in the Source form of any Derivative Works that You distribute, all copyright, patent, trademark, and attribution notices from the Source form of the Work, excluding those notices that do not pertain to any part of the Derivative Works; and

(d) If the Work includes a "NOTICE" text file as part of its distribution, then any Derivative Works that You distribute must include a readable copy of the attribution notices contained within such NOTICE file, excluding those notices that do not pertain to any part of the Derivative Works, in at least one of the following places: within a NOTICE text file distributed as part of the Derivative Works; within the Source form or documentation, if provided along with the Derivative Works; or,

within a display generated by the Derivative Works, if and wherever such third-party notices normally appear. The contents of the NOTICE file are for informational purposes only and do not modify the License. You may add Your own attribution notices within Derivative Works that You distribute, alongside or as an addendum to the NOTICE text from the Work, provided that such additional attribution notices cannot be construed as modifying the License.

You may add Your own copyright statement to Your modifications and may provide additional or different license terms and conditions for use, reproduction, or distribution of Your modifications, or for any such Derivative Works as a whole, provided Your use, reproduction, and distribution of the Work otherwise complies with the conditions stated in this License.

5. Submission of Contributions. Unless You explicitly state otherwise, any Contribution intentionally submitted for inclusion in the Work by You to the Licensor shall be under the terms and conditions of this License, without any additional terms or conditions. Notwithstanding the above, nothing herein shall supersede or modify the terms of any separate license agreement you may have executed with Licensor regarding such Contributions.

6. Trademarks. This License does not grant permission to use the trade names, trademarks, service marks, or product names of the Licensor, except as required for reasonable and customary use in describing the origin of the Work and reproducing the content of the NOTICE file.

7. Disclaimer of Warranty. Unless required by applicable law or agreed to in writing, Licensor provides the Work (and each Contributor provides its Contributions) on an "AS IS" BASIS, WITHOUT WARRANTIES OR CONDITIONS OF ANY KIND, either express or implied, including, without limitation, any warranties or conditions of TITLE, NON-INFRINGEMENT, MERCHANTABILITY, or FITNESS FOR A PARTICULAR PURPOSE. You are solely responsible for determining the appropriateness of using or redistributing the Work and assume any risks associated with Your exercise of permissions under this License.

8. Limitation of Liability. In no event and under no legal theory, whether in tort (including negligence), contract, or otherwise, unless required by applicable law (such as deliberate and grossly negligent acts) or agreed to in writing, shall any Contributor be liable to You for damages, including any direct, indirect, special, incidental, or consequential damages of any character arising as a result of this License or out of the use or inability to use the Work (including but not limited to damages for loss of goodwill, work stoppage, computer failure or malfunction, or any and all other commercial damages or losses), even if such Contributor has been advised of the possibility of such damages.

9. Accepting Warranty or Additional Liability. While redistributing the Work or Derivative Works thereof, You may choose to offer, and charge a fee for, acceptance of support, warranty, indemnity, or other liability obligations and/or rights consistent with this License. However, in accepting such obligations, You may act only on Your own behalf and on Your sole responsibility, not on behalf of any other Contributor, and only if You agree to indemnify, defend, and hold each Contributor harmless for any liability incurred by, or claims asserted against, such Contributor by reason of your accepting any such warranty or additional liability.

END OF TERMS AND CONDITIONS

APPENDIX: How to apply the Apache License to your work.

To apply the Apache License to your work, attach the following boilerplate notice, with the fields enclosed by brackets "[]" replaced with your own identifying information. (Don't include the brackets!) The text should be enclosed in the appropriate comment syntax for the file format. We also recommend that a file or class name and description of purpose be included on the same "printed page" as the copyright notice for easier identification within third-party archives.

Copyright [yyyy] [name of copyright owner]

Licensed under the Apache License, Version 2.0 (the "License");
you may not use this file except in compliance with the License. You may obtain a copy of the License at

<http://www.apache.org/licenses/LICENSE-2.0>

Unless required by applicable law or agreed to in writing, software distributed under the License is distributed on an "AS IS" BASIS, WITHOUT WARRANTIES OR CONDITIONS OF ANY KIND, either express or implied.

See the License for the specific language governing permissions and limitations under the License.

5-073-602-11(1) Copyright 2026 Sony Corporation